

KAISAI

CATALOGUE

AIR CONDITIONING SYSTEMS

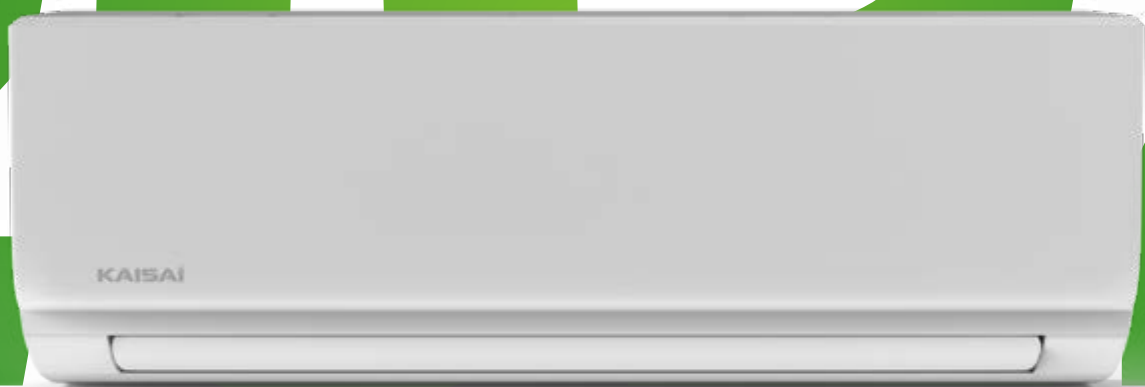

AIR CONDITIONING | VENTILATION | HEATING | PHOTOVOLTAICS

Take sustainability to a new level

CARE FOR THE ENVIRONMENT WITH US

kaisai.com 

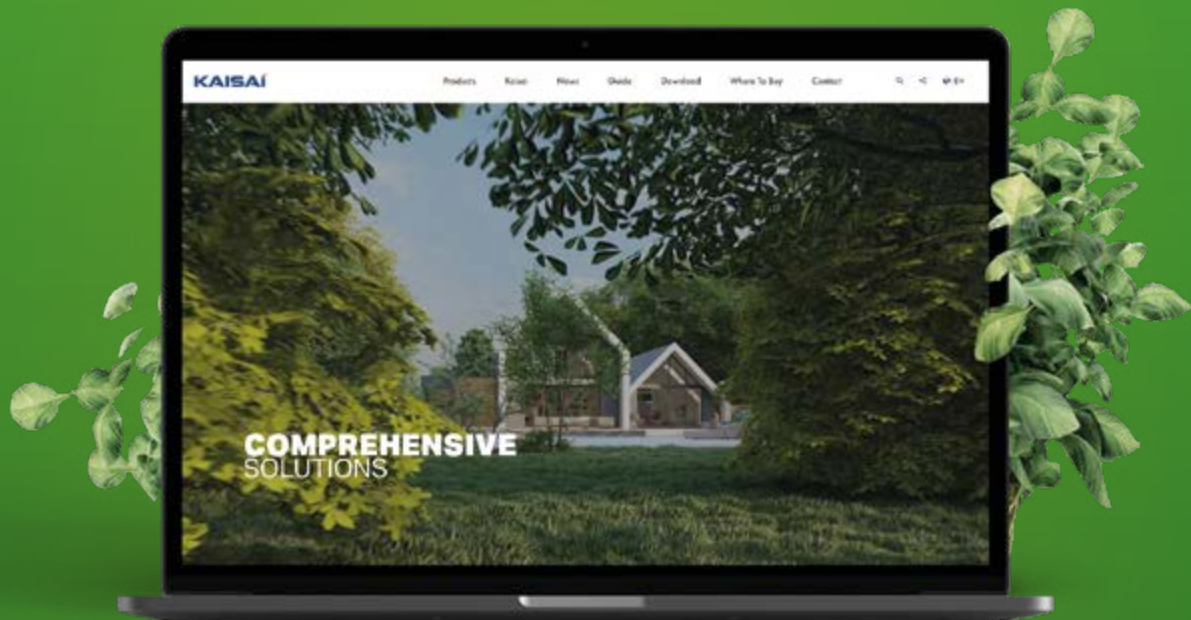

360° PRODUCT
VIEW



FULL RANGE
OF DEVICES



CLEAR
DESIGN



INTUITIVE
OPERATION



24H ACCESS
TO CATALOGUES

Making one tonne of paper from recycled paper **saves as much as 17 trees and 1200 litres of water.** By using the kaisai.com website, you have all the catalogues at your fingertips and, most importantly, you contribute to environmental protection. **The earth is our planet – let us care for it together.**

TABLE OF CONTENTS

About the Kaisai brand	6
User guide	12
How to choose an air conditioner?	14
Environmental protection	17
Renewable energy sources	20
Heat Pumps	22
Photovoltaic modules	24
Heat recovery units	26
The key functionalities	28
Modern filters	34
Technologies	36
Overview of functions	40
Product range	48
Wall-mounted air conditioners	50
Fly wall-mounted air conditioners	52
One+ wall-mounted air conditioners	56
Care wall-mounted air conditioners	60
Geo wall-mounted air conditioners	64
Hot wall-mounted air conditioners	68
#290 wall-mounted air conditioners	72
Multi Split systems	76
Commercial air conditioners	82
Floor air conditioners	84
Floor and ceiling air conditioners	88
Kompakt cassette air conditioners	92
Kompakt cassette air conditioners	96
Slim duct air conditioners	100
Condensing units	104
Portable air conditioners	108
Kpph mobile air conditioners	110
Kppd mobile air conditioners	112
Wired and wireless controllers	114
Dimensions of the units	116
Accessories	126
Filters	129
Contact details	131



WE CARE ABOUT AIR

5

We feel responsible for both people and the environment. We take care of air quality and comfort – in the office, at home and in all the rooms where we work and stay every day.

As much as we care about the air, we care about our business environment both near and far. Following the idea of sustainable development, we have set ourselves priorities based on a pro-environmental approach to business, partnership with the client and care for human resources.



SOLUTIONS

TAILORED TO YOUR NEEDS

GET TO KNOW
THE RANGE OF
PRODUCTS FROM
KAISAI
[KAISAI.COM](https://www.kaisai.com)



WALL-MOUNTED
AIR CONDITIONERS



MULTI SPLIT
SYSTEMS



CASSETTE
AIR CONDITIONERS



AIR CONDITIONING • VENTILATION • HEATING • PHOTOVOLTAICS

When you choose Kaisai appliances, you get a high-quality, environmentally friendly product designed for user comfort, yet offered at a reasonable price.

The Kaisai brand debuted on the Polish market in 2011 and since then it has recorded sales growth every year in Poland and in foreign markets. The latest technological solutions make Kaisai appliances leaders in their class, meeting high expectations in terms of environmental care, energy savings,

quiet operation, safety, user comfort and manufacturer's warranty. Through many years of investment in technology, KAISAI equipment is considered to be some of the most innovative air conditioning solutions for public and residential buildings.

OVER
600
AUTHORISED SERVICE
POINTS IN POLAND

OVER
500000
UNITS SOLD
IN POLAND

30
TYPES
OF PRODUCTS



FLOOR AND CEILING
AIR CONDITIONERS



FLOOR
AIR CONDITIONERS



CONDENSING
UNITS



PORTABLE
AIR CONDITIONERS

THINK GLOBALLY WORK LOCALLY

As part of the Kaisai International Corporation business platform, following the principle **Think globally – work locally**, the Kaisai brand is present in the following countries:

- Austria
- Belgium
- Belarus
- Bulgaria
- Czech Republic
- Denmark
- Estonia
- Finland
- France
- Greece
- Georgia
- The Netherlands
- Luxembourg
- Lithuania
- Latvia
- North Macedonia
- Malta
- Moldova
- Germany
- Norway
- Poland
- Portugal
- Romania
- Slovakia
- Slovenia
- Switzerland
- Sweden
- Ukraine
- Hungary
- Italy

Kaisai's portfolio includes RAC segment equipment (including wall-mounted air conditioners with Wi-Fi as a standard) and LCAC segment equipment (including Multi Split, ceiling cassette, duct and floor/ceiling air conditioners), as well as portable air conditioners, heat pumps, heat recovery units and air curtains.

KAISAI

WHEREVER YOU ARE

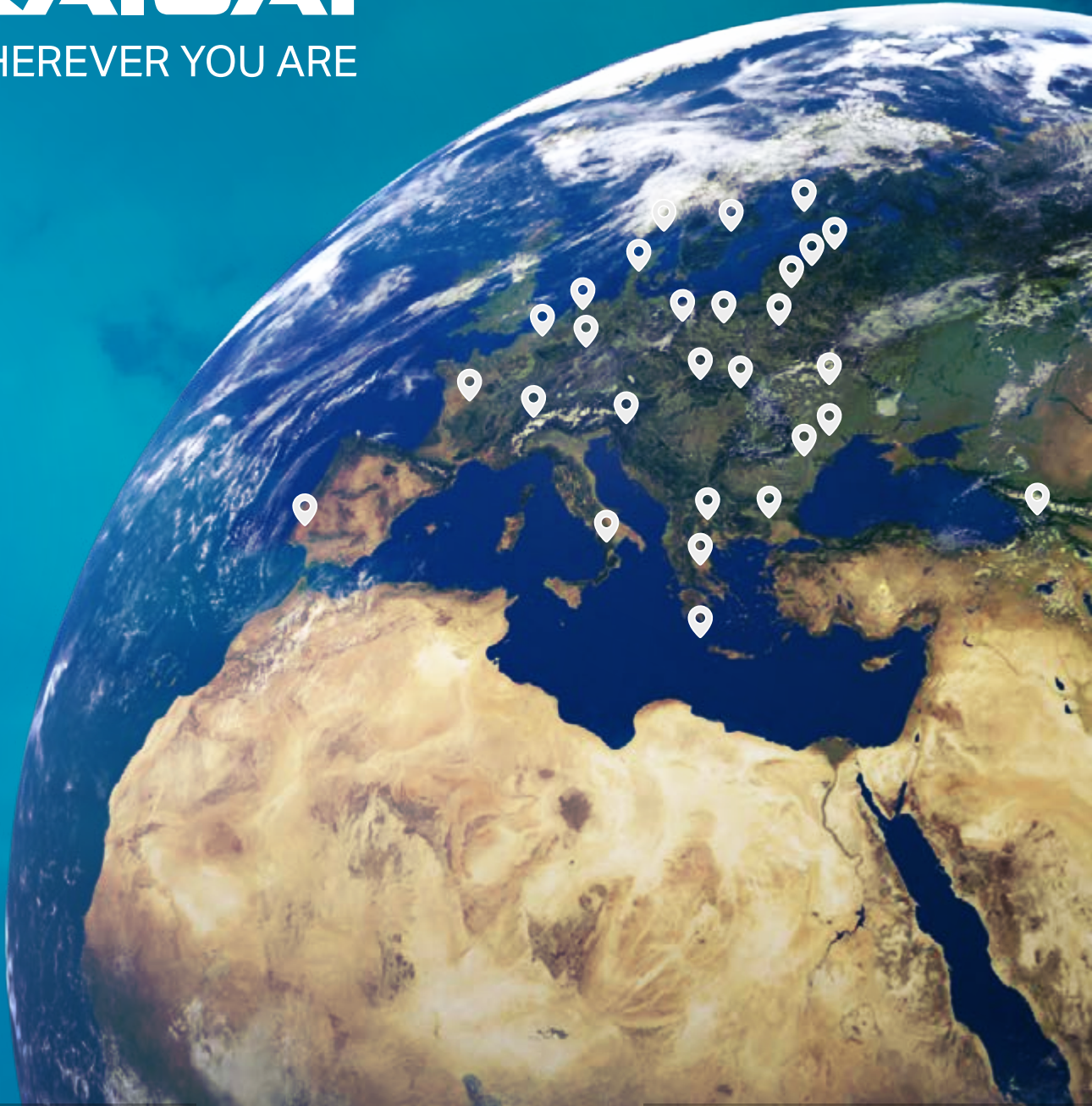

33

COUNTRIES

OVER
1000

OUTLETS

OVER
650000

UNITS SOLD
WORLDWIDE



Academy of

KLIMA-THERM GROUP

The Academy of Klima-Therm Group offers training at the highest level, carried out on modern facilities, with the support of an experienced team of trainers – experts in the air conditioning industry.



Academy of Klima-Therm Group is an innovative educational and research project, whose main goal is to constantly raise the knowledge of the industry environment in the field of current trends in air conditioning and ventilation, and the latest product solutions, technology and design. Thanks to the activities of the Academy, customers can be sure of the expertise of our installers: it is a guarantee of the safety and failure-free operation of our equipment.

Kaisai is committed to the highest quality of its products and installations. By being a part of Klima-Therm Group, Kaisai Authorised Service Partners benefit from training opportunities offered by the Academy. The trained installers not only receive theoretical knowledge, but can also acquire practical skills under the guidance of qualified trainers. The Academy has 3 training centres serving clients from all over Poland: in Gdańsk, Warsaw and Katowice.

CE

ISO
9001:2000

A++
(EU)626/2011

A+
(EU)626/2011

ATEST
PZH

Kaisai products meet stringent requirements related to safety of use, health protection and environmental protection, and as a result have obtained various designations and certifications. The refrigerants used are approved by the National Institute of Public Health.



Develop WITH KLIMA-THERM ACADEMY



PRODUCT
TRAINING



AUTHORISATION
TRAINING



TECHNICAL
TRAINING



EQUIPMENT
TESTS



HOW TO CHOOSE
AN AIR CONDITIONER?

ENVIRONMENTAL
PROTECTION

THE KEY
FUNCTIONALITIES

User guide

13

With the wide range of air conditioning systems on offer today, it is important to consider which units will be suitable for a particular facility before making a purchase.

Different types of air conditioners will be suitable for cooling and heating purposes in a house, while completely different types will be suitable for an office building or shopping mall. The correct choice of air conditioner type and performance is a prerequisite for satisfaction. It is best to entrust the selection of equipment in terms of efficiency to specialists with the relevant knowledge and experience.

How to choose

KAISAI AIR CONDITIONING?

The correct choice of an air conditioner's capacity for an apartment is the basis for efficient air conditioning at home or in the workplace. A unit with not enough power will not cool the room air to the required temperature. And equipment with more power than needed is more expensive to buy and operate. So how do I choose an air conditioner for my existing conditions?

From March to September, days are longer and temperatures are higher. Especially between June and August, there are periods of several weeks of hot weather, which can cause discomfort when staying indoors. It's worth thinking about this beforehand, ensuring the ideal, comfortable air temperature regardless of the time of year or day.



USE UP TO
4 TIMES **LESS**
ELECTRICITY

Air conditioning was previously associated mainly with office space. It is now within the financial reach of individual users. Additionally, thanks to the heating function available in modern units, air conditioners can also serve as an additional source of heat during colder periods. Air conditioning is an efficient and economical alternative to fans and electric heaters – it uses up to 4 times less electricity.



EFFICIENCY



HEALTH



SAFETY



EACH SPLIT AIR CONDITIONER CONSISTS OF **TWO COMPONENTS:**

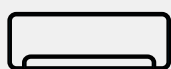

indoor unit



outdoor unit

The former one is installed inside and the latter – outside of the building.



COMFORT AND **HEALTH**

Air conditioning is available to everyone. It allows you to freely control the temperature in your home, flat, office or small retail outlet; it replaces or complements central heating. But the advantages of installing air conditioning do not end there. Installing it proves to be an excellent way to ensure the health of all users.

Modern air conditioners eliminate bacteria and fungi from the air, preventing the diseases they cause, and special filters improve overall air quality. Air conditioning is also a good solution for maintaining the correct air parameters when the outside air is heavily polluted, e.g. with smog.



COST OF OPERATION

In principle, domestic air conditioning differs in power consumption from industrial air conditioning, which is more demanding in this respect. The 2.6 kW unit uses less than 1 kW of electricity per hour of operation, which translates to a cost of around 50 groszys.* There are a number of general recommendations and indicators that allow the user to initially determine the required power of the appliance himself. The most important parameter is the cubic capacity of the air-conditioned room. It is assumed that for standard rooms with a height of approximately 3 m, a cooling power of 40 W/m³, i.e. 120 W per m² area is required. This means that for a room of 21 m² even the smallest air conditioner with an output of 2.6 kW may be sufficient.

* example cost, calculated for Warsaw (Poland), for a private user.

HOW DOES AN **AIR CONDITIONER** WORK?

The principle of the air conditioner's operation is based on the physical properties of the refrigerant, which in the case of Kaisai units is the environmentally friendly R32 refrigerant. Depending on the operating mode of the air conditioner, the refrigerant condenses or evaporates in the indoor unit – giving up or drawing heat from the environment, respectively. In this way, the air in the room is heated or cooled and, thanks to a system of filters, also purified.

The unit does not blow additional air from the outside, but only cools the inside. This makes it possible to care for the health of users, especially during periods of smog.

High energy class

SAVE MONEY ALL YEAR LONG

A+++

The more economical the appliance is, the higher its energy class. When buying an air conditioner, it is therefore worth paying attention to ensure that the energy class of the air conditioner is at least A-rated.

When the air conditioner is running, remember to close the windows in the air-conditioned room, thus contributing to savings in energy bills. Do not set the room temperature too low on the remote control, as such a setting can result in increased running costs, among other things.



17

WHAT IS **GWP**?

Global warming potential. Is a figure expressing the potential impact that a refrigerant could have on global warming if released into the atmosphere. It is a relative value comparing the impact of 1 kg of refrigerant with the impact of 1 kg of CO₂ over a period of 100 years.

WHAT IS **ODP**?

Ozone Depletion Potential is an indicator, which refers to the harmful effects that chemicals cause to the ozone layer. This is a value comparing the impact of a given refrigerant with the equivalent mass of Freon R11. ODP for Freon R11 is defined as 1, while a modern refrigerant R32 has a potential defined as 0.

Environmentally friendly R32 refrigerant

THROUGHOUT THE KAISAI RANGE



Attention to environmental protection and energy efficiency of the equipment are among the basic principles of the KAISAI brand. The entire range of Kaisai air conditioners now uses the latest environmentally friendly refrigerant R32.

It is more efficient than previously used, so the air conditioning system requires less of it, and has a much better environmental impact factor. It is a modern solution taking into account both environmental needs and economy of use.



ENVIRONMENTALLY FRIENDLY

R32 has one of the lowest GWP values available on the market – 675, it also does not cause damage to the ozone layer thanks to the ODP value equal to 0.



ECONOMICAL

Compared to R410A, R32 is more energy-efficient, that is why less refrigerant is required by the cooling system and equipment efficiency is increased by up to 10%.



SAFE

R32 has low toxicity and is almost non-flammable – it does not pose a threat to life and health even in case of system leaks.

Safe refrigerant R290

IN MOBILE AIR CONDITIONERS

The refrigerant R290 is known by the common name propane – a colourless, odourless organic compound belonging to the group of saturated hydrocarbons naturally occurring in natural gas deposits.

Propane-based equipment has been operating successfully in various EU countries for many years. Its popularity continues to grow due to its low environmental impact while maintaining very good thermodynamic properties.

R290 has low sensitivity to moisture and is non-corrosive, making it suitable for use in refrigeration systems equipped with both hermetic and semi-hermetic compressor units.



ZERO ODP

R290 has a zero ODP, meaning no negative impact on the ozone layer, and an extremely low GWP, which indicates its impact on global warming. Propane is a flammable gas and its flammability limit is 2.1% by volume in air. This means that with 230 g of R290 refrigerant in Kaisai appliances and thanks to special fire protection, it is also safe for use in enclosed spaces.



Renewable

ENERGY SOURCES

Renewable energy sources (RES) are based on natural resources, the extraction of which ensures not only zero-emission energy production but also a wide range of possibilities for its use.

Due to relatively easy access to technology and the possibility for it to be used by companies and individual households, the most popular solutions are the units which obtain energy from the air and the sun. Kaisai's product range provides state-of-the-art RES solutions that include air-to-water heat pumps, heat recovery units, and photovoltaic modules and inverters.

20

Bet on green energy

ALL YEAR

Due to relatively easy access to technology and the possibility for it to be used by companies and individual households, the most popular solutions are the units that obtain energy from the air and the sun.

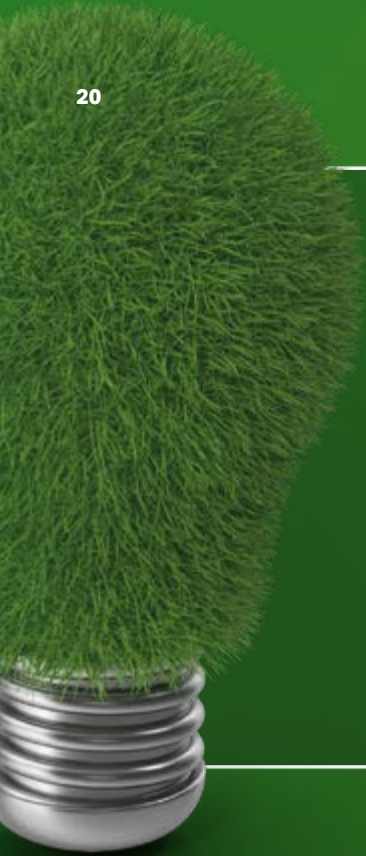
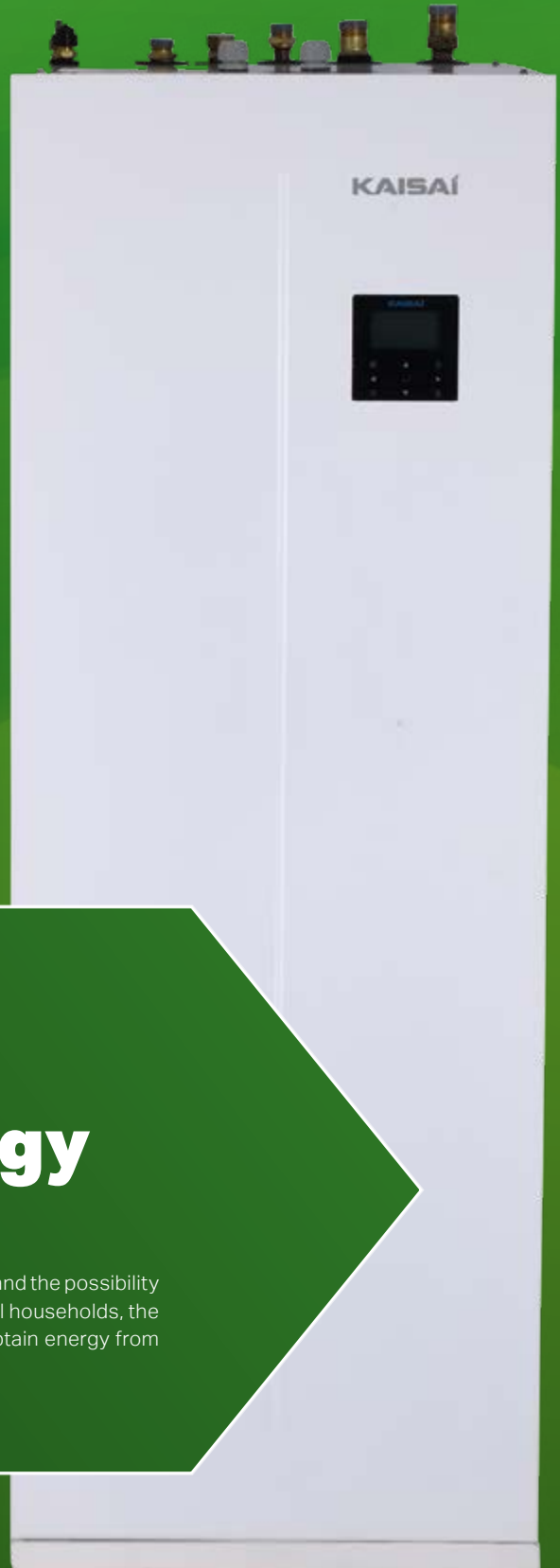

Our offer includes:

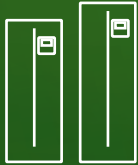

HEAT PUMPS

Thanks to the cutting-edge technology, air-water KAISAI heat pumps operate in a very wide range of outside temperatures and achieve high temperatures in the heating system or for domestic hot water.



PHOTOVOLTAIC MODULES

KAISAI photovoltaic modules with special cell design allow the electrode resistance to be decreased and a lower current to be achieved, thus improving the module efficiency.



PHOTOVOLTAIC INVERTERS

KAISAI inverters are a series of devices with the highest technical parameters, ensuring efficient operation in any conditions. Flexible installation, and a compact and lightweight aesthetic design enable general and flexible use in domestic and commercial projects.



HEAT RECOVERY UNITS

Kaisai heat recovery units are high-efficiency devices for mechanical ventilation of homes, flats, offices and shops, designed and manufactured in accordance with the latest technological trends.



**The full range of products based
on renewable energy sources
is available on our website**

kaisai.com

Environmentally friendly in every way

CARE FOR THE ENVIRONMENT WITH US



22

The heat pump draws free energy from the air and uses it to heat and cool the building, or prepare domestic hot water. It is a cheap, ecological and reliable heat source, which can be used by anyone.

Thanks to cutting-edge technology, Kaisai heat pumps operate in a wide range of outside temperatures and achieve the high temperature parameters of the heating system or domestic hot water. No emission of harmful substances into the environment, operational safety, and maintenance-free make the Kaisai heat pumps an ideal solution for everyone who builds a house as well as replaces or retrofits the current heat source. The Kaisai heat pumps can be used in single-family, multifamily, and commercial buildings.



Heat pumps

ECOLOGIC ENERGY SOURCE

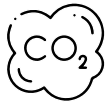

REDUCED CO2 EMISSIONS

Heat pumps are an ideal alternative to gas and coal-fired boilers, helping to reduce CO2 emissions into the atmosphere. While operating at the time selected by the user, the devices do not produce smoke, ash or any other substances harmful to the environment.

The full range of products based on renewable energy sources is available on our website

kaisai.com



COMFORT ALL YEAR LONG

A heat pump transfers heat from the air to the water, heating it up. Thanks to its automation, the heat pump ensures user comfort and simple operation. The convenient indoor temperature and the desired domestic water parameters are set using an intuitive controller. The user does not have to worry about „firing up the boiler“, as the unit will automatically maintain a comfortable level of temperature throughout the year.



LOW OPERATING COSTS

Heat pumps make a significant contribution to reducing the house's operating costs. The cost of heating and domestic hot water can be reduced by up to four times with a heat pump. The use of a heat pump also reduces system maintenance costs, e.g., as chimney inspections are not needed.

Use the heat from the air TO HEAT YOUR HOME

Heat pumps are one of the environmentally friendly energy sources, because instead of coal, gas or oil, they use the potential of the air, using refrigerants that have a significantly lower impact on the environment than non-renewable energy sources. The electric power supply also allows the use of home photovoltaics in the so-called passive house system (i.e. without drawing energy from outside).



Modules and inverters

EFFICIENT AND QUIET OPERATION IN ALL CONDITIONS

Photovoltaics is the conversion of sunlight into electricity, taking place using modules made up of cells connected in series in a frame. It is a stable and inexhaustible source of green energy that does not pollute the environment.

A photovoltaic installation enables the creation of a low- or zero-energy building. By producing its own electricity and storing it in the grid, a household is able to meet its needs for domestic hot water, powering household appliances, heating and recuperation.

KAISAI photovoltaic modules with special cell design allow the electrode resistance to be decreased and a lower current to be achieved, thus improving the module efficiency. This reduces losses caused by partial shading and cell wear, while increasing the solar energy conversion capacity.

24



Inverters

Kaisai inverters are modern devices working on proven quality microprocessor chips. They ensure efficient, high-performance and trouble-free operation in the installation and enable monitoring of all parameters of the photovoltaic system, allowing the optimal amount of energy to be extracted.

OPERATION PRINCIPLE

The solar inverter converts the direct current produced by the photovoltaic panels into alternating current with parameters compatible with those of the power grid. It also monitors the performance of the home solar power plant and automatically tracks the power point to capture the maximum

amount of energy from the solar panel array. At dusk, when the intensity of sunlight is too low to generate electricity, the inverter automatically switches off and restarts during the day when the input voltage reaches its initial value.

Photovoltaic modules

FOR YOUR HOME AND OFFICE

Full range of products based on renewable energy sources available on our website

kaisai.com

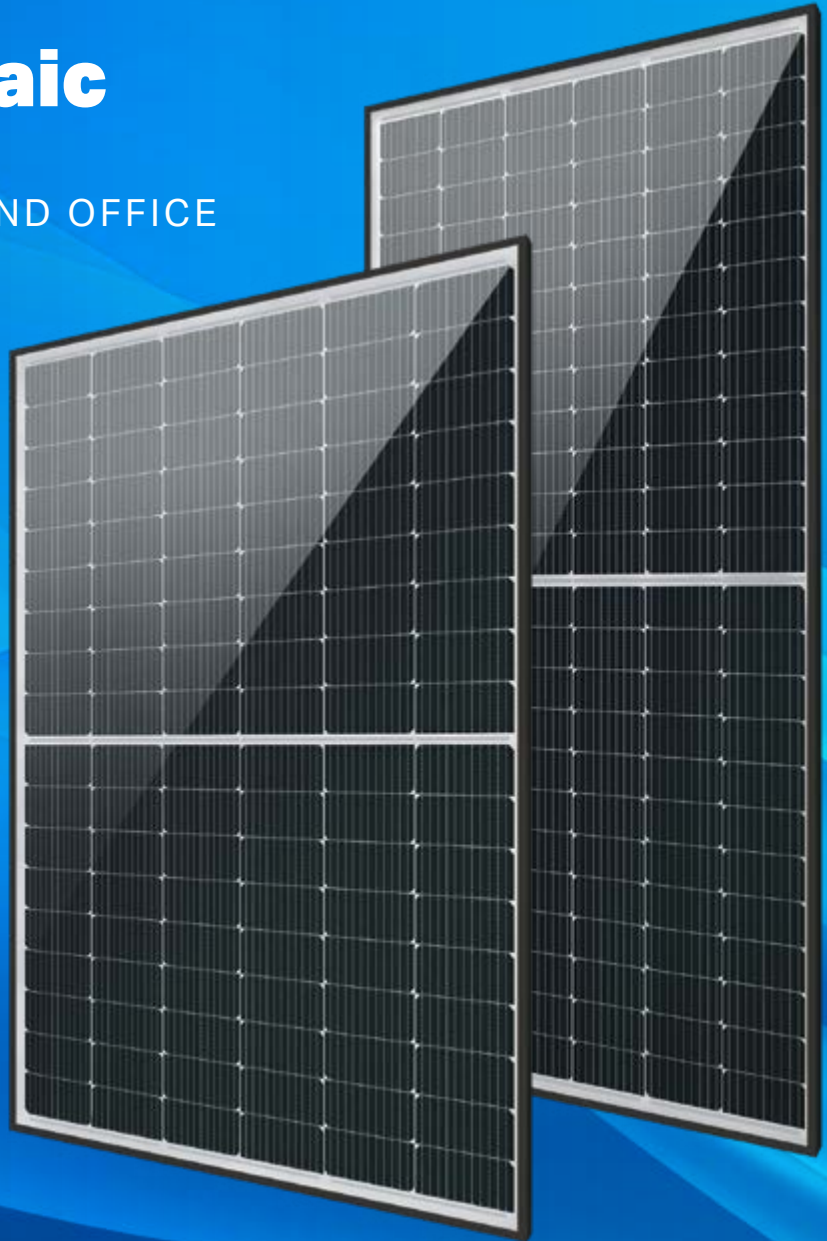

25



HIGHEST WATER
RESISTANCE CLASS
THE JUNCTION BOX



RESISTANCE
TO HARSH
CONDITIONS



RESISTANCE
TO WIND
AND SNOW LOAD



Heat recovery units

HIGHEST AIR COMFORT

Recuperation is a type of mechanical ventilation supplemented with heat recovery. A heat recovery unit makes it possible to control the movement of the air supplied to the room and to recover heat from the polluted air coming from inside the house. Additionally, the filters installed in the unit clean the air of pollutants, allergens and smog.

Kaisai heat recovery air handling units are high-efficiency ventilation units with heat recovery for mechanical ventilation of homes, offices and stores. During their operation, they exchange the exhaust air from the interior with the air drawn from the outside, purified by means of a special high-performance class F7 filter. The counter-current heat recovery exchanger prevents heat loss, recovering up to 92.5% of the energy during the winter. The recovered heat is transferred to the clean air entering the rooms.

The full range of products based on renewable energy sources is available on our website

kaisai.com

26

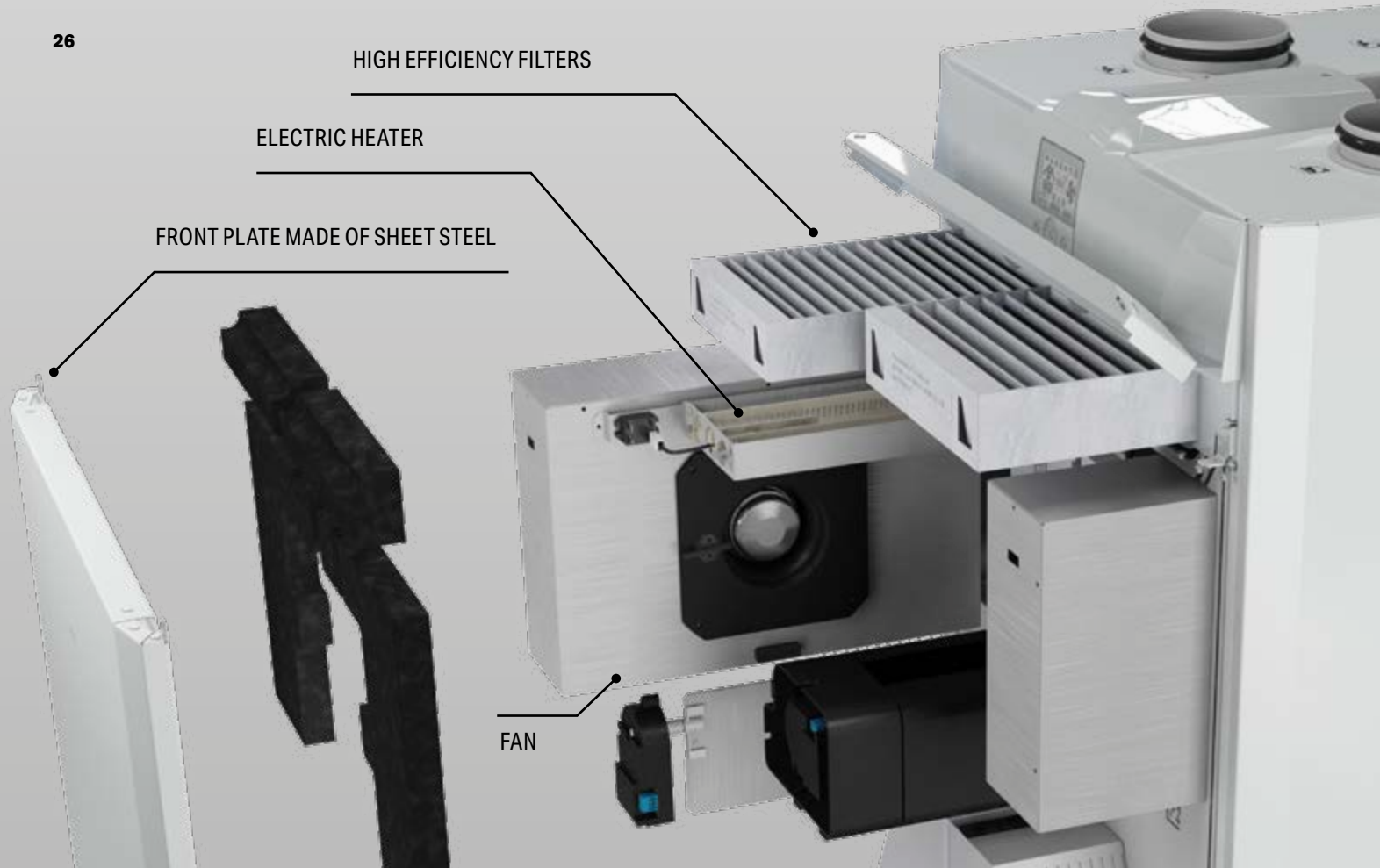

Energy efficiency

CLASS OF KAISAI APPLIANCES

	SEER (Cooling mode)	SCOP (Heating mode)
A⁺⁺⁺	SEER ≥ 8,50	SCOP ≥ 5,10
A⁺⁺	6,10 ≤ SEER < 8,50	4,60 ≤ SCOP < 5,10
A⁺	5,60 ≤ SEER < 6,10	4,00 ≤ SCOP < 4,60
A	5,10 ≤ SEER < 5,60	3,40 ≤ SCOP < 4,00
B	4,60 ≤ SEER < 5,10	3,10 ≤ SCOP < 3,40
C	4,10 ≤ SEER < 4,60	2,80 ≤ SCOP < 3,10
D	3,60 ≤ SEER < 4,10	2,50 ≤ SCOP < 2,80
E	3,10 ≤ SEER < 3,60	2,20 ≤ SCOP < 2,50
F	2,60 ≤ SEER < 3,10	1,90 ≤ SCOP < 2,20
G	SEER < 2,60	SCOP < 1,90

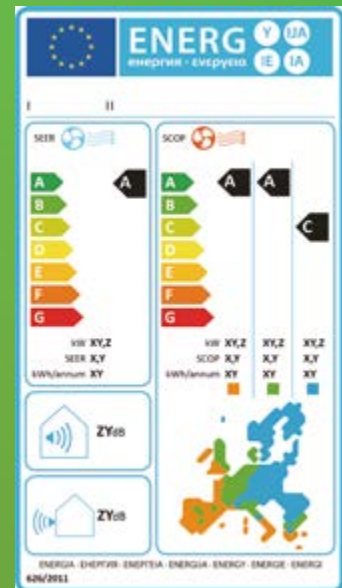

CURRENT ENERGY LABEL

Applicable from 1 January 2013 Air conditioners up to 12 kW

Energy labels are placed on every domestic electrical appliance sold in the European Union. This is regulated by a special EU Directive 2010/30/EU. Labels inform the user about the quality of the product, taking into account, in particular, its energy efficiency. Before purchasing, the label allows everyone to compare which device will be the cheapest in terms of operation. The energy efficiency rating, also known as energy class, is indicated by letters: for air conditioners a scale from G (lowest) to A+++ (highest) has been established.

We also use seasonal energy efficiency factors to evaluate energy savings: SEER for cooling and SCOP for heating. These ratios determine the ratio between the cooling/heating power achieved by the air conditioner and the electrical power drawn by the unit from the mains for an entire season. Units with SEER=6 and SCOP=4 (A++ class) can generate 6 kW of cooling energy or 4 kW of heating energy from one kW of electricity on average per season and can be up to 4 times cheaper to run than electric fans and heaters.

10-grade energy efficiency scale (from A+++ to G)

Power consumption efficiency for cooling and heating

Performance rating based on a multi-feature calculation, corresponding to the actual power consumption of the unit during operation

Sound power level

Data for 3 seasons (temperate – required, warm and cool – optional)

Modern functions of units

TECHNOLOGY FOR YOU



28

Advanced features of Kaisai appliances ensure high comfort, convenience and safety of use as well as economic and efficient operation. Using modern purification functions means you always have clean air in your home – free of viruses, allergens and smog.

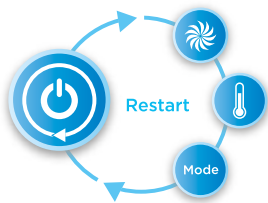

AUTOMATIC **RESTART**

For units equipped with the auto restart function, when power is interrupted the air conditioner remembers the last settings and automatically resets them when power is restored.

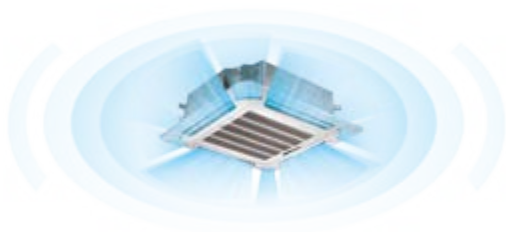

360° AIR SUPPLY

The cassette air conditioners are equipped with additional supply slots in the panel. Thanks to this design, the 360° unit can provide even better air distribution in the conditioned room.



TEMPERATURE **SENSOR**

The temperature sensor is built into the remote control. In this way, temperature measurements are taken at the user's location, while the air conditioner's operation is adjusted to the actual conditions in the room.



OPERATION AT **LOW OUTSIDE TEMPERATURES**

Thanks to a specially designed control board, the air conditioner can operate in the cooling function even with outdoor temperatures as low as -25°C.

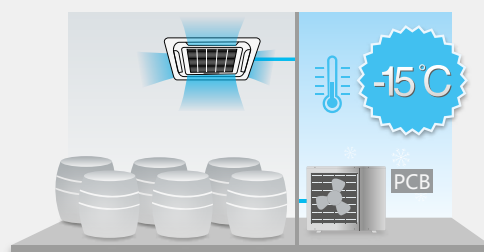

3D AIR SUPPLY

The horizontal and vertical blinds of the air conditioner are controlled automatically, in order to ensure uniform temperature distribution in the room and optimal air circulation.

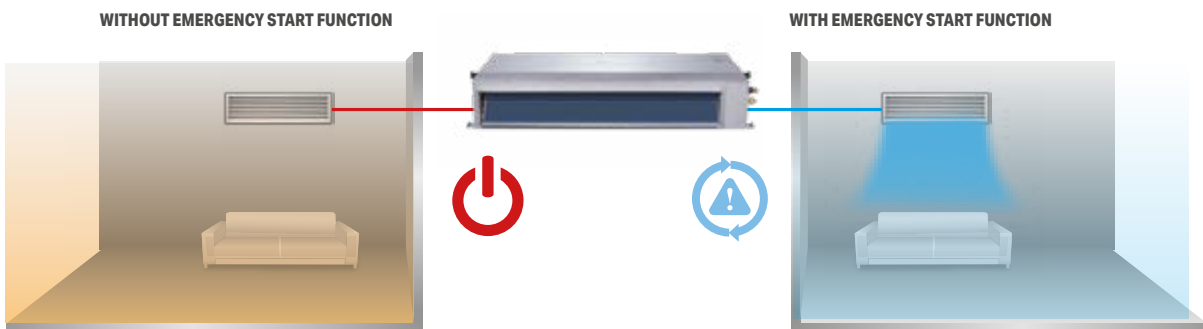

EMERGENCY USE

The emergency use function of the air conditioner allows the unit to operate even if one of the sensors has failed. With this solution, the operation of the air conditioner is not interrupted and it can be used until the fault is rectified.

30



FRESH AIR

Outside air can be supplied through a connection duct to the air conditioner, thus improving the air quality in the room.

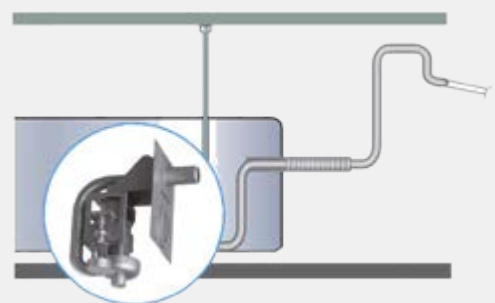

BUILT-IN CONDENSATE PUMP

Thanks to the integrated condensate pump, it is possible to remove condensate up to a height of 1000 mm.

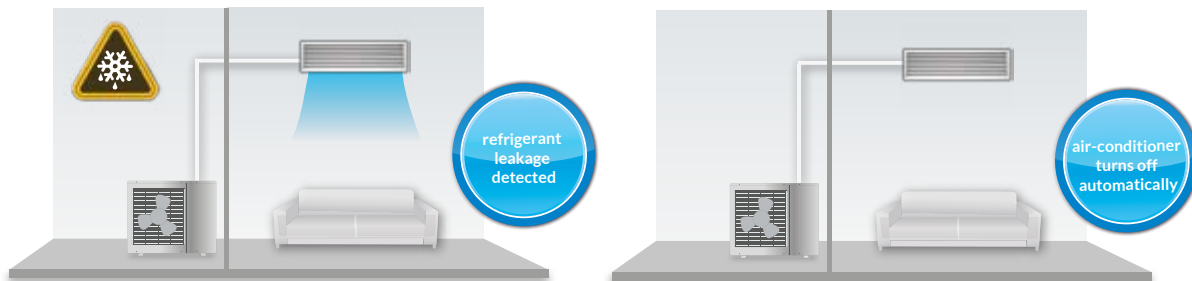

REFRIGERANT LEAKAGE INDICATION

The air conditioner has a refrigerant leakage indication function. If the unit records a leakage, the EC message will appear on the display of the indoor unit and the air conditioner will automatically switch off. This function additionally protects the compressor from being damaged.

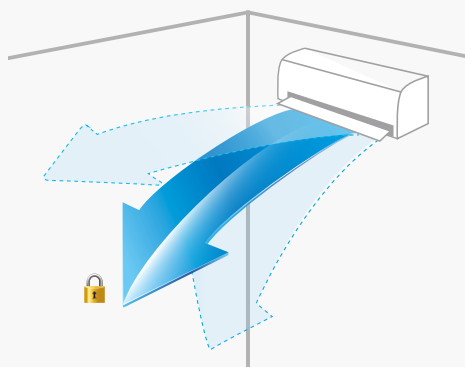

BLINDS SETTINGS MEMORY

Thanks to the function of saving the blinds settings, the air conditioner keeps the last settings after it is switched off and restores them when restarted.

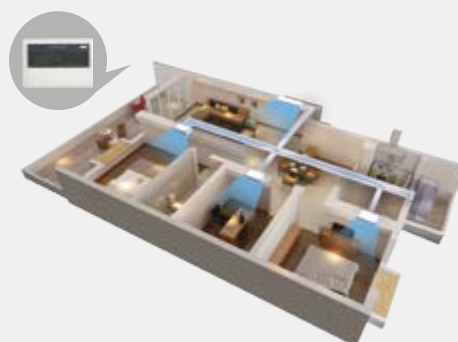



CENTRAL CONTROLLER

Option to connect a central controller, controlling up to 64 indoor units.

TWIN SYSTEM

The TWIN simultaneous system makes it possible to connect two indoor units of the same type and capacity to a single unit (outdoor unit). This solution improves air distribution in air-conditioned rooms and saves installation space by installing only one outdoor unit.

This system is ideal for air-conditioning large spaces such as conference and banquet halls, open-plan offices, restaurants and other service and commercial buildings. In a twin system, one indoor unit must be set as master and the other as slave. Only the master unit can accept the control signal from the remote control, the slave unit only performs the settings of the master unit.

Outdoor unit	Indoor unit	Branch pipe
 KOD30U-36HFN(J)32X	2 x KUE-18HRG32X	UTP-SX236
	2 x KTI-18HWG32X	
 KOE30U-48HFN32X	2 x KCD-24HRG32X	UTP-SX254A
	2 x KUE-24HRG32X	
	2 x KTI-24HWG32X	

INSTALLATION DIAGRAM FOR **SIMULTANEOUS TWIN SYSTEM**

To avoid system malfunction, use Kaisai brand triple connectors. The indoor units should be installed in equal numbers on both sides of the U-type triple connector.

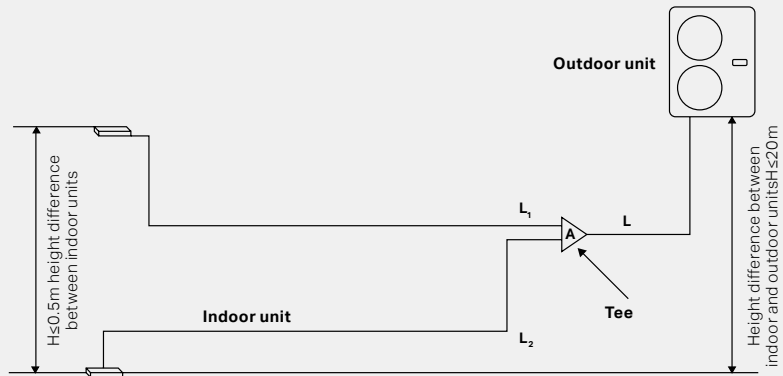

	Acceptable value	Installation
Installation length	Total installation length (active)	18K+18K 30m 24K+24K 50m
	Maximum branch length	15m
	Maximum branch length difference	10m
Height difference	Maximum height difference between indoor and outdoor units	20m
	Maximum height difference between indoor units	0,5m



FIXED HEATING 8°C

The function of maintaining a constant temperature of 8°C in heating mode is a particularly useful solution for holiday homes and detached houses.

It keeps the air conditioner at a constant temperature of up to 8°C; it prevents rooms from cooling down and pipes from freezing. This counteracts the build-up of moisture and thus the growth of micro-organisms and fungi.

Air conditioners with this option are a more efficient solution than the commonly used thermostatically controlled electric heaters.

This is the hallmark of Kaisai brand home air conditioners. Combined with Smart AC and the ability to set the temperature remotely, this makes our products ideal for users who are often away from home.

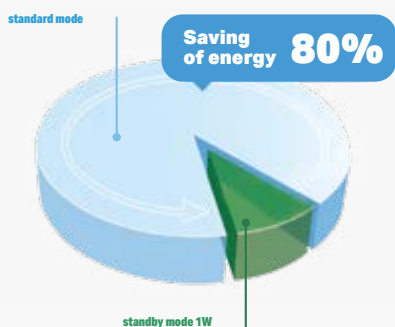

STANDBY MODE

In standby mode, power is disconnected from unused electronic components, reducing power consumption to 1 watt compared to standard devices, which consume an average of 5 watt in this mode, achieving savings of approximately 80%.

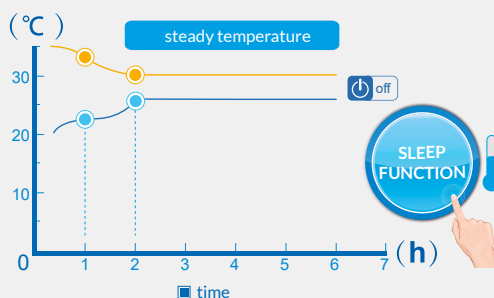

SLEEP FUNCTION

Activating the sleep function causes the unit to raise the temperature set in cooling mode (lower in heating mode) by 1°C per hour within two hours. During this time the fan runs at low speed. After 5 hours, the air conditioner switches off. Slow, hardly noticeable temperature changes and automatic switching off guarantee comfort and energy savings.

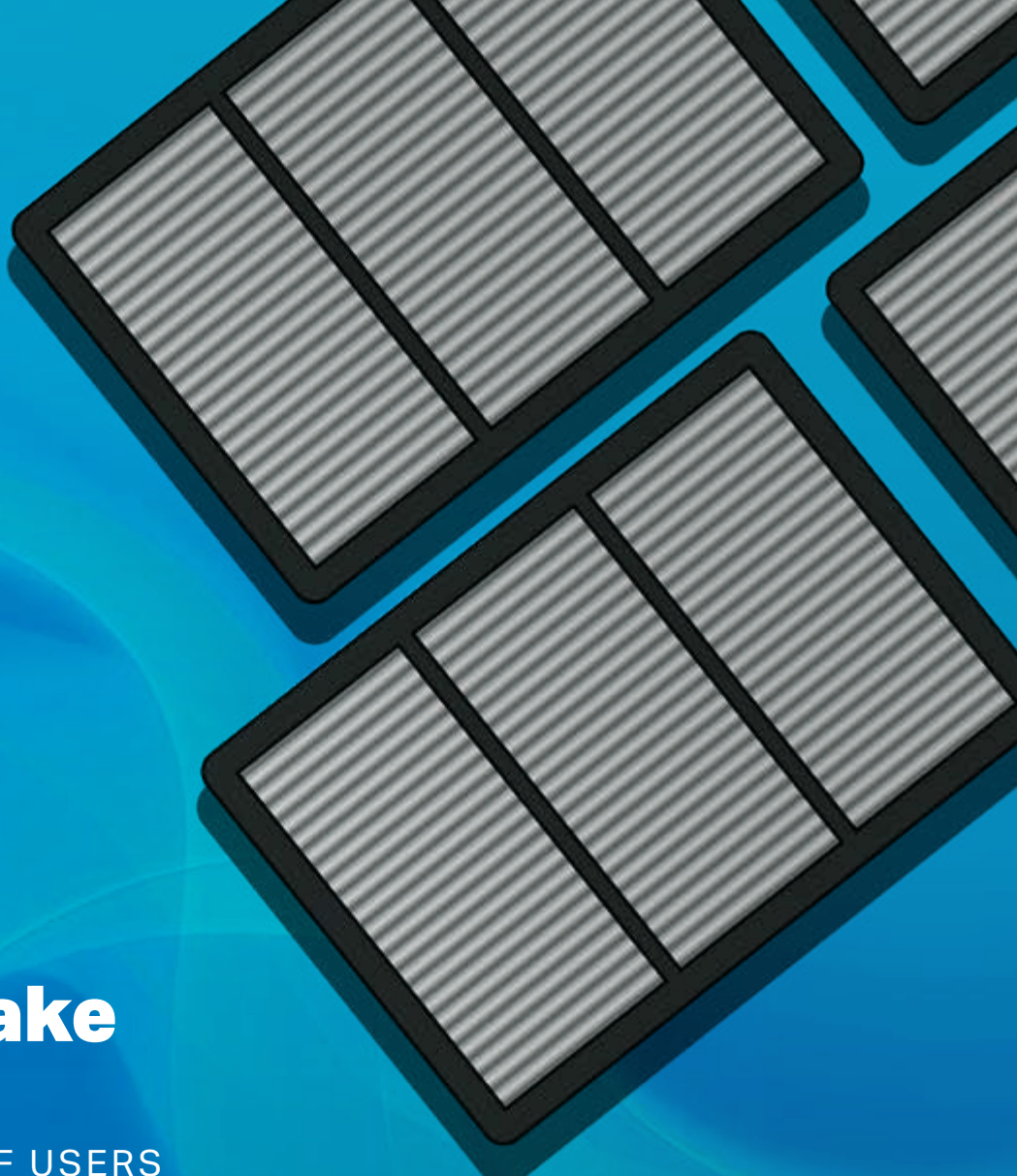

34

For the sake of health

AND COMFORT OF USERS

Modern filters used in Kaisai brand products guarantee clean and fresh air in the air-conditioned room. They capture very small dust particles, bacteria, fungi and germs, leaving healthy and clean air.

SELF-CLEANING EXCHANGER

To ensure the highest standards of hygiene and comfort, Kaisai brand appliances use the latest self-cleaning technology for the internal exchanger. The air conditioner enters cleaning mode after it completes its operation. It removes any moisture that may have accumulated in the unit, which prevents the growth of micro-organisms and fungi.



SILVER ION FILTER

The silver ion filter is responsible for destroying bacteria and preventing the growth of micro-organisms such as viruses and fungi. The internal structure of the silver ions destroys micro-organisms.

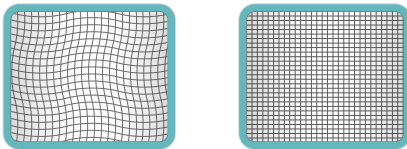

VITAMIN C FILTER

The filter emits vitamin C, which has a positive effect on the skin by protecting it from the sun's rays. As an active antioxidant, vitamin C has a nourishing effect, stimulates collagen production and reduces stress.

35

HIGH DENSITY FILTER

The use of high-density filters significantly increases the efficiency of dirt retention – by up to 50%.

3M FILTER

Thanks to its unique design, the filter captures dust particles and other harmful substances from the air, which can cause many respiratory diseases.

NEW

BIOHEPA FILTER

The air purification function is further supported by the Bio HEPA filter, which effectively traps 99% of dust particles and bacteria measuring 0.3 μm and up to 95% of particles from 0.1 to 0.3 μm , including fungal cells and some viruses.

NEW

COLD CATALYTIC FILTER

The cold-catalytic filter eliminates chemicals such as carbon monoxide, hydrogen sulphide, ammonia, benzene and formaldehydes.

Modern technologies

USED IN KAISAI APPLIANCES

Kaisai appliances are characterised by high quality workmanship and the use of modern technology – all for the user's convenience. Efficient and comfortable air conditioning is now available to everyone.



heating [°C] **-25 ÷ 30**

cooling [°C] **-15 ÷ 50**

36

TOTAL INSTALLATION LENGTH

Kaisai split units have the option of installing the outdoor and indoor units far apart – up to 75 m in total length and up to 30 m in vertical height. This makes it much simpler to lay out appliances even in older buildings. You do not have to adapt your home design to air conditioning – we adapt it for you.

OPERATING TEMPERATURE

By using modern technology and the new refrigerant R32, Kaisai air conditioners can operate in a wide range of outdoor temperatures: from -15°C to 50°C in cooling mode and from -25°C to 30°C in heating mode. They can fulfil their purpose all year round, guaranteeing users can enjoy the comfort of cool in summer and additional heating in winter.



DIMENSIONS AND DESIGN

We make every effort to ensure that Kaisai units follow the latest design trends: we want the air conditioner to please the eye with its tasteful form and fit in with modern interior design trends. In addition, when designing indoor cassette and duct units, we are mindful of the space they occupy. Thanks to the optimum size of the units, the suspended ceiling does not require much technical space and thus leaves more usable space.



INVERTER TECHNOLOGY

The inverter technology in the Kaisai's units reduces power consumption, which is related to the reduction of room cooling and heating costs. Its use translates to the quiet operation of the unit and faster achievement of the desired temperature.

By using durable and high-pressure resistant materials, the compressor in Kaisai's heat pumps is extremely reliable. In addition, it has a high-efficiency motor with a wide voltage range, which is why it can operate in extreme conditions in 24-hour mode and reach temperatures of up to 60°C (230V/50Hz).



HIGH PERFORMANCE MOTOR



BROAD VOLTAGE RANGE



DURABLE COMPRESSOR MATERIAL



RESISTANCE TO HIGH PRESSURE

Commercial air conditioners

EFFECTIVE COOLING AND REAL COMFORT

38

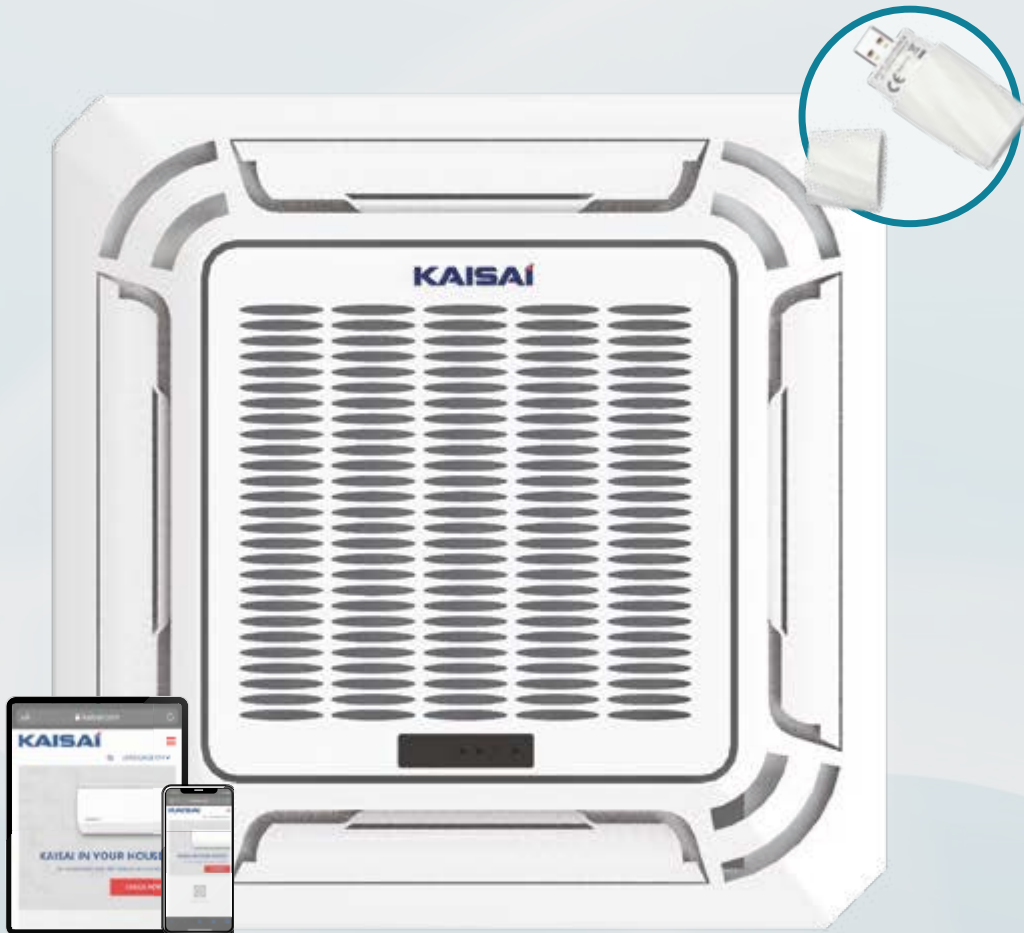

CHANGING
OPERATING MODE,
TEMPERATURE, AND
FAN SPEED



PREVIEW OF DEVICE
OPERATION
INFORMATION



MOBILE APP FOR
ADROID AND IOS

**SMART PORT IS A WI-FI
MODULE FOR COMMERCIAL
KAISAI AIR CONDITIONERS**

Wi-Fi control can now be used not only for wall-mounted air conditioners, but also for other models of Kaisai air conditioners.

Wall-mounted air conditioners

ELEGANT APPEARANCE AND COMFORT OF USE

Kaisai products incorporate several features improving the comfort of use; for example, new control options have been added so that managing air conditioning has never been so convenient and simple.

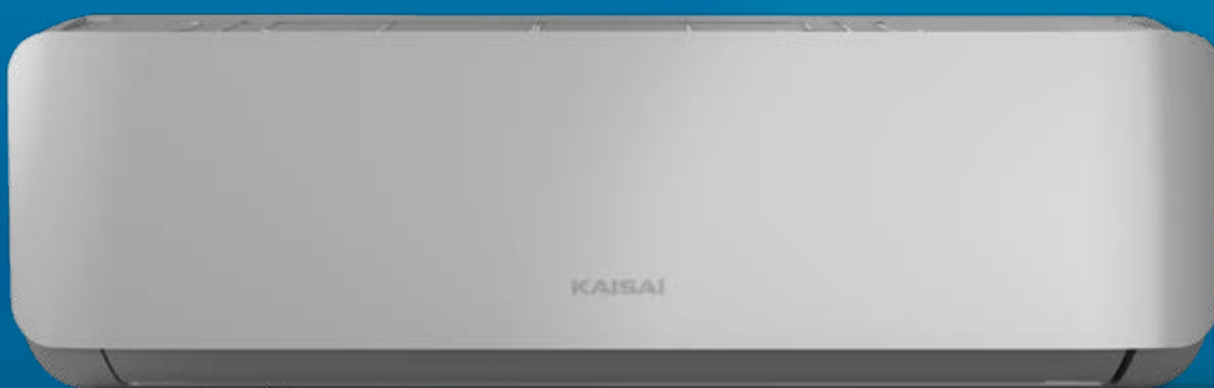

39

SMART AC

Smart AC is a Wi-Fi module added as standard to all Kaisai wall air conditioner models. Thanks to its use, the user can control the device via an application installed on a tablet or smartphone, even when away from home or the office.

Using the Wi-Fi function, the user is able to switch the unit on or off, change the temperature and selected operating functions from any place in the world with Internet access. Wi-Fi control allows you to save electricity and increase the comfort of air conditioning by controlling the temperature in your home or office from any location.



NETHOME PLUS APPLICATION

Reliable operation of the Smart AC system is ensured by the Nethome Plus app installed on a tablet or smartphone. **Download the app by scanning the QR code**

Enable the innovative capabilities of your unit

DISCOVER ALL KAISAI FUNCTIONS



40

Kaisai air conditioners are equipped with a number of modern features that, in addition to providing the right temperature, allow you to enjoy the comfort of breathing clean air every day.

Advanced features of Kaisai appliances are also convenience and safety of use, as well as economical and efficient operation.

COMFORTS

**TIMER**

The timer gives you the option to set the time for automatic switching on and off of the air conditioner.

**MONO AND MULTI**

The indoor unit is versatile and can be used in single (mono-split) and multiple (multi-split) arrangements.

**CENTRAL CONTROLLER**

Option to connect a central controller, controlling up to 64 indoor units.

**SIMPLE INSTALLATION**

The air conditioner is designed to be easy to install and require no extra steps.

**MULTI-DIRECTIONAL CASTORS**

Thanks to the integrated castors, relocating the air conditioner is easy.

**DOUBLE-SIDED INSTALLATION**

Refrigerant supply and condensate drainage pipes can be connected on both sides of the indoor unit for easy installation and adaptation to the room layout.

**YEAR-ROUND OPERATION SET**

The year-round set includes electric crankcase heaters for the compressor and the condensate tray of the outdoor unit and a thermostat for controlling their operation. The set supports the operation of the air conditioner in heating mode and prevents icing of the outdoor unit.

**AUTOMATIC BLINDS (SWING)**

The automatic operation of horizontal blinds significantly improves the air distribution in the room.

**PERSONALISED REMOTE CONTROL**

Option of changing the factory settings of the remote control in order to adapt it to the current needs of the user.

**BLINDS SETTINGS MEMORY**

After each shutdown, the air conditioner remembers the last blinds settings and restores them when restarted.

**ON-OFF PORT**

The air conditioner has a port that allows it to be switched on and off remotely (using a potential-free signal).

**WI-FI CONTROL**

The Wi-Fi module allows you to control the air conditioner using your phone or tablet from anywhere in the world.

**TWIN COMBINATION**

Two identical indoor units operate simultaneously, connected to a single outdoor unit.

**BUILT-IN CONDENSATE PUMP**

Thanks to the integrated pump, it is possible to remove condensate up to a height of 1000 mm.

**COMPACT DIMENSIONS**

Well-planned components make the air conditioner small while retaining full performance parameters.

**LARGE INSTALLATION RANGE**

The indoor and outdoor units can be up to 50 m apart in total installation length and up to 25 m apart in vertical installation height.

**VERY LARGE INSTALLATION RANGE**

Indoor and outdoor units can be spaced up to 75 m apart in total installation length and up to 30 m apart in vertical installation height.

Features that help you look after your health

HEALTH



IONISATION

The ions emitted by the air conditioner break down particles of dust mites, mould, bacteria and viruses, eliminating them from the environment, and humidify the air, which has a positive effect on the skin and gives a pleasant feeling of freshness.



BIOHEPA FILTER

The air purification function is supported by a Bio HEPA filter that effectively traps 99% of dust, dirt and bacteria particles of 0.3 µm and up to 95% of particles from 0.1 to 0.3 µm, including fungal cells and some viruses.

42



VITAMIN C FILTER

The filter emits vitamin C into the room, which is absorbed by the skin. The vitamin increases skin firmness, protects against harmful UV rays and also reduces stress.



STERILISATION AT 56°C

The air is heated in an internal exchanger to 56°C, which destroys the organic DNA and RNA structures of bacteria and viruses, including SARS-CoV-2.



SILVER ION FILTER

This filter contributes to the elimination of bacteria and other harmful micro-organisms through the use of active silver ions. It ensures a high standard of air hygiene.



DOUBLE FILTRATION

The double filtration system that the air conditioner is equipped with effectively stops pollen and dust, absorbs dust mites and removes unwanted odours from the air.



3M FILTER

This filter, thanks to its unique design, more efficiently captures dust and harmful allergic substances from the air, which cause respiratory tract diseases.



FRESH AIR

Fresh outside air is supplied to the unit via a connecting pipe. This significantly improves the air quality in the room.



HIGH DENSITY FILTER

The use of a high-density filter improves the efficiency of the retention of contaminants, including dust and particles. Not only does it protect the appliance but also takes care of the air quality.



UV LAMP

The process of UV emission effectively removes bacteria, viruses, mould and fungi from the air and prevents their multiplication.



COLD CATALYTIC FILTER

The cold catalytic filter removes chemicals such as carbon monoxide, hydrogen sulphide, ammonia, benzene and formaldehydes.

COMFORT

**SMOOTH FAN SPEED ADJUSTMENT**

This function allows smooth control of the indoor unit's fan capacity in a range of 1-100%.

**AUTOMATIC RESTART**

During a power outage, the air conditioner remembers the last settings and restores them when power is resumed. No need to reprogramme the device every time the power is switched off.

**3D AIR SUPPLY**

The horizontal and vertical blinds of the air conditioner are controlled automatically, in order to ensure uniform temperature distribution and optimal air circulation.

**TURBO MODE**

With this option, the air conditioner operates at an increased speed and provides rapid cooling or heating of the room.

**TEMPERATURE COMPENSATION**

The unit compensates for differences in the temperature sensor reading on the indoor unit compared to the actual temperature at the room floor. The desired temperature is achieved throughout the room, not just around the air conditioner.

**MULTIFUNCTIONAL REMOTE CONTROL**

Using the remote control, you can easily set the appropriate air parameters in the room. In addition, the remote control is equipped with practical functions such as: self-cleaning evaporator (SELF CLEAN), constant heating at 8°C (HEATING 8°C), temperature sensor (FOLLOW ME).

**VANE FUNCTION**

With this option, the user can individually control each of the air conditioner's blinds, directing the airflow where they choose.

**BREEZE AWAY FUNCTION**

This function allows the blinds to be set in parallel so that the air supply from the unit is not directed directly at the user.

**EVAPORATOR SELF-CLEANING**

After operation, the air conditioner goes into cleaning mode and removes any moisture that may have accumulated in the indoor unit. This prevents the growth of micro-organisms and fungi.

**360° AIR SUPPLY**

The unit can provide the best air distribution throughout the room thanks to the additional supply slots in the air conditioner panel.

**BROAD TEMPERATURE RANGE**

Operating in a wide range of outdoor temperatures. In cooling mode from -15 to 50°C and from -25 to 30°C in heating mode.

**COLD AIR SUPPLY CONTROL**

To minimise the feeling of unpleasant cold airflow, the air conditioner automatically reduces the fan speed when it starts to operate in heating mode and increases it as the air warms up.

**COMPRESSOR AND CONDENSATE TRAY HEATER**

The compressor crankcase heater prevents absorption of the refrigerant by the oil, which may occur when the temperature drops. The drip tray heater assists the air conditioner's operation in heating mode by preventing ice build-up, improving efficiency and minimising the risk of fan failure.

**QUIET OPERATION**

Possibility to set the minimum sound level of the unit in the conditioned room.

MONEY SAVING



8°C CONTINUOUS HEATING FUNCTION

When the user is away, in heating mode, the air conditioner keeps the room at a constant temperature of up to 8°C, preventing it from cooling down.



STANDBY MODE

In standby mode, disconnecting power from unused components reduces power consumption by up to 80%.



SLEEP FUNCTION

The unit raises the temperature set in cooling mode (lower in heating mode) by 1°C per hour within two hours and the fan operates at a low speed. This reduces electricity consumption and the air conditioning provides the best comfort for the user.



5 FAN SPEEDS FOR THE OUTDOOR UNIT

Thanks to inverter technology, the outdoor unit has 5 operating modes, which increases energy efficiency and improves comfort.



TEMPERATURE SENSOR IN REMOTE CONTROL

The temperature sensor built into the remote control allows it to be measured closer to the user, allowing the device to more accurately match the environment.



ECO

With the Eco function activated, the appliance consumes up to 60% less energy compared to conventional operation.



GEAR FUNCTION

With the Gear Mode's ability to control the temperature and speed of air supply, it is possible to control electricity consumption and decide on the maximum intensity level.



12 FAN SPEEDS FOR THE INDOOR UNIT

Adjusting the 12 fan speeds of the indoor unit allows you to ensure maximum comfort in the room and save electricity.

44

SAFETY



CONDENSATE EVAPORATION

The condensed water is transported to the condenser where it evaporates. This eliminates the need for a condensate tank.



REFRIGERANT LEAKAGE INDICATION

The error code will be displayed on the control panel of the indoor unit when the outdoor unit detects a refrigerant leakage.



OPERATION AT LOW OUTSIDE TEMPERATURES

The air conditioner operates in cooling mode even when the outside temperature reaches -15°C.



EMERGENCY USE

If one of the sensors fails, the operation of the unit is not interrupted and it can be used until the fault is rectified.



OPERATION AT VERY LOW OUTSIDE TEMPERATURES

The air conditioner even works at outdoor temperatures as low as -25°C.



SELF-DIAGNOSIS

The air conditioner monitors its operation and shuts down if it detects a malfunction or failure. The error code is displayed on the control panel of the indoor unit.



ALARM PORT

The air conditioner has an alarm port from which a fault signal can be connected.

Explore solutions you did not know

KAISAI RANGE OF APPLIANCES

KAISAI offers modern solutions ensuring comfort and efficient cooling of rooms inside the house - the living room, the bedroom or the children's room.

The universal design of KAISAI air conditioners blends perfectly with the furnishings of any interior, and the high energy efficiency parameters ensure economical operation with low energy consumption.



WALL-MOUNTED AIR CONDITIONERS

Compact dimensions ensure a subtle, elegant appearance, and a range of unit types allows them to adapt to a variety of interiors – whether for home use, offices or retail outlets.

COMMERCIAL AIR CONDITIONERS

Commercial buildings require equipment that provides a particularly efficient air conditioning system. Depending on the area and purpose of the facility, we can apply floor, floor/ceiling, cassette, duct, or condensing units.

45

MULTI SPLIT SYSTEMS

These systems are recommended for facilities requiring multi-room air conditioning. All the advantages of split appliances are retained with a single outdoor unit.

PORTABLE AIR CONDITIONERS

Portable air conditioners are used where it is not possible to install split air conditioning. They match the décor of home and office spaces thanks to their modern design.







































































































































































A planet-friendly home

SOLUTIONS FOR THE 21ST CENTURY

kaisai.com 



















Eco-friendly air conditioning, ventilation and heating systems reduce electricity consumption, giving real benefits during use. The offered Kaisai brand appliances are not only a high class of energy efficiency, but also innovative functionality that will meet the needs of the most demanding customers.

		WALL	FLOOR	FLOOR AND CEILING	CASSETTE COMPACT	CASSETTE SUPER SLIM	DUCT SLIM	PORTABLE
	 STANDARD  OPTIONAL							
	Self-cleaning evaporator							
	High-density filter							
	The 3D air supply							
	Automatic restart							
	360° air supply							
	Temperature compensation							
	Cold air control							
	Wide temperature range							
	8°C continuous heating function							
	Standby mode							
	Sleep function							
	Temperature sensor in remote control							
	Condensate evaporation							
	Operation at low outside temperatures							
	Refrigerant leakage indication							
	Emergency use							
	Self-diagnosis							
	Alarm port							
	Timer							
	Automatic blinds (swing)							
	Mono and multi							
	Simple installation							
	Twin combination							
	Double-sided installation							
	Fresh air							
	Blinds settings memory							
	On-off port							
	Multidirectional castors							
	Wi-Fi control							
	Built-in condensate pump							

Series of

KAISAI AIR CONDITIONING APPLIANCES

TYP	PAGE NUMBER	COOLING / HEATING CAPACITY [kW]				
		2,6	3,5	5,3	6,0	7,0÷7,2
WALL-MOUNTED AIR CONDITIONERS						
 FLY	53	•	•	•		•
 ONE+	57	•	•	•		•
 CARE	61		•	•		
 GEO	65		•	•		
 HOT	79		•			
 #290	73		•			
SYSTEMY MULTI SPLIT						
 OUTDOOR UNITS	89			•		
 WALL	80	•	•	•		•
 CASSETTE COMPACT	81	•	•	•		
 DUCT	81			•		
COMMERCIAL AIR CONDITIONERS						
 FLOOR	85					
 FLOOR AND CEILING	99			•		•
 CASSETTE COMPACT	93		•	•		
 CASSETTE SUPER SLIM	97					•
 DUCT SLIM	101			•		•
 CONDENSING UNITS	105		•	•		•
KLIMATYZATORY PRZENOŚNE						
 KPPH	110	•				
 KPPD	112		•			

48

COOLING / HEATING CAPACITY [kW]

7,9÷8,2

9,0

10,0

10,6

12,0÷12,4

14,0÷14,1

15,2÷15,8

	••			•	•		

						•	
				•		•	•
				•		•	•
				•		•	•
				•		•	•



50

Wall-mounted air conditioners

51

The compact dimensions of the wall-mounted units provide an elegant appearance and comfort of use, combined with high efficiency and simple installation.

All wall-mounted KAISAI air conditioners use the environmentally friendly R32 refrigerant, and standard accessories include the Wi-Fi function to control the unit using mobile devices. Depending on the model, there is a number of practical functions available for intuitive control and the optimum adaptation of the device to the needs of the user.

52



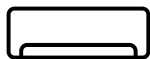

KWX 09 | 12 | 18 | 24 HRGI

fly

The energy-efficient Kaisai Fly wall air conditioner with R32 refrigerant combines elegance with functionality. Its universal, timeless design makes it fit into any interior.

The unit stands out for its ability to heat at outdoor temperatures as low as -25°C. The Wi-Fi function as standard increases the convenience of air conditioning control, and a modern wireless remote control allows you to use 3 additional functions: self-cleaning evaporator (Self Clean), constant heating at 8°C (Heating 8°C) and temperature sensor in the remote control (Follow Me).





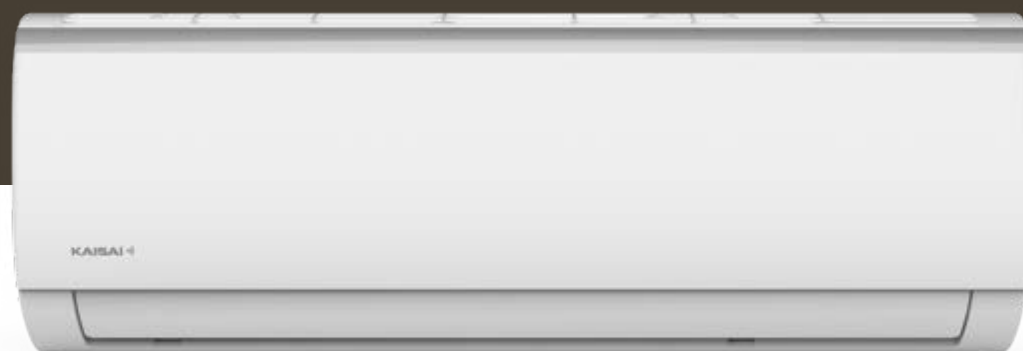



















A⁺

R32





Features of Kaisai Fly

- | | | | | | | | | | | | | |
|---|---|---|---|---|---|---|---|--|---|---|---|---|
|  |  |  |  |  |  |  |  |  |  |  |  |  |
| Wide temperature range | High-density filter | Blinds settings memory | Refrigerant leakage indication | Operation at low outside temperatures | Multi-functional remote control | Emergency use | Cold-catalytic filter | Wi-Fi control | Standby mode | Heating function 8°C | Turbo mode | Self-cleaning evaporator |
|  |  |  |  |  |  |  |  |  |  |  |  | |
| 3D air supply | Sleep function | Mono and multi | Timer | Automatic restart | Self-diagnosis | Remote control temperature sensor | BIO HEPA filter | Compressor and condensate tray heaters | Silver ion filter | Vitamin C filter | 3M filter | |

Technical specification

MODEL	indoor unit		KWX-09HRGI	KWX-12HRGI	KWX-18HRGI	KWX-24HRGI
	outdoor unit		KWX-09HRGO	KWX-12HRGO	KWX-18HRGO	KWX-24HRGO
Capacity average (min÷max)	cooling	kW	2,6(0,9÷3,4)	3,5(1,1÷4,2)	5,3(2,9÷5,8)	7,0(2,1÷7,9)
	heating	kW	2,9(0,8÷3,4)	3,8(1,1÷4,2)	5,6(3,1÷5,8)	7,3(1,6÷7,9)
Energy class	cooling/heating		A++/A+	A++/A+	A++/A+	A++/A+
SEER	average	W/W	6,3	6,1	7,4	6,1
SCOP	average	W/W	4,0	4,0	4,0	4,0
Average power consumption (min÷max)	cooling	W	732(100÷1240)	1213(130÷1580)	1550(560÷2050)	2600(420÷3150)
	heating	W	733(120÷1200)	1088(100÷1680)	1570(780÷2000)	2400(300÷2750)
Average operating current (min÷max)	cooling	A	3,2(0,4÷5,4)	5,3(0,5÷6,9)	6,7(2,4÷8,9)	11,5(1,8÷13,8)
	heating	A	3,2(0,5÷5,2)	4,7(0,4÷6,9)	6,8(3,4÷8,7)	11,0(1,3÷12,2)
Air flow rate	indoor	m³/h	466/360/325	540/430/314	840/680/540	980/817/662
	outdoor	m³/h	1750	1800	2100	3500
Operating temperature cooling/heating	indoor	°C	17÷32/0÷30	17÷32/0÷30	17÷32/0÷30	17÷32/0÷30
	outdoor	°C	-15÷50/-25÷30	-15÷50/-25÷30	-15÷50/-25÷30	-15÷50/-25÷30
Sound pressure level	indoor	dB(A)	38,5/32/25/21	40,5/34,5/25/21	42,5/36/26/20	45/40,5/36/30
	outdoor	dB(A)	55,5	56	56	59
Net dimensions w/h/d	indoor	mm	805/285/194	805/285/194	957/302/213	1040/327/220
	outdoor	mm	720/495/270	720/495/270	805/554/330	890/673/342
Transport dimensions w/h/d	indoor	mm	870/365/270	870/365/270	1035/385/295	1120/405/315
	outdoor	mm	835/540/300	835/540/300	915/615/370	995/740/398
Net weight	indoor	kg	7,6	7,6	10,0	12,3
	outdoor	kg	23,2	23,2	32,7	42,9
Transport weight	indoor	kg	9,7	9,8	13,0	15,8
	outdoor	kg	25,0	25,0	35,4	45,9
Pipe diameter: liquid/gas		mm	6,35/9,52	6,35/9,52	6,35/12,7	9,52/15,9
Maximum installation length		m	25	25	30	50
Maximum height difference		m	10	10	20	25
Power supply	outdoor	V/Hz/Ph	220÷240/50/1	220÷240/50/1	220÷240/50/1	220÷240/50/1
Circuit breaker/fuse	outdoor	A	10	16	16	20
Power supply lines	outdoor	# of wires x mm²	3x1,5	3x1,5	3x2,5	3x2,5
Control lines	ind. - outd.	# of wires x mm²	5x1,5	5x1,5	5x1,5	5x1,5
Factory amount of refrigerant	up to 5 rm	kg	0,55	0,55	1,08	1,42
Additional amount of refrigerant	over 5 rm	g/m	12	12	12	24

* Additional electric heaters, compressor and condensate tray are required for heating operation at outdoor temperatures below -15°C.

55

Controllers

WIRELESS
REMOTE CONTROL



RG10B1

WIRELESS
REMOTE CONTROL



**RG66A1
(OPTIONAL)**

WIRED REMOTE
CONTROL



**KJR12B
(OPTIONAL)**

WIRED REMOTE
CONTROL



**KJR90A
(OPTIONAL)**



56



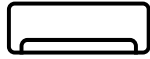

KRX 09 | 12 | 18 | 24 PEGI

one+

Energy-efficient devices combining modern design with exceptional simplicity of installation, maintenance and cleaning.

The new design of the air conditioner, and the optimised arrangement of the individual components inside the unit, save time during installation and daily operation. Through the use of modern technology and R32 refrigerant, the air conditioner can operate in a wide range of outdoor temperatures. Comfort of use is provided by a modern wireless remote control and a Wi-Fi function as standard, to control the device using your mobile phone or tablet.

57

A⁺⁺ | R32 | 

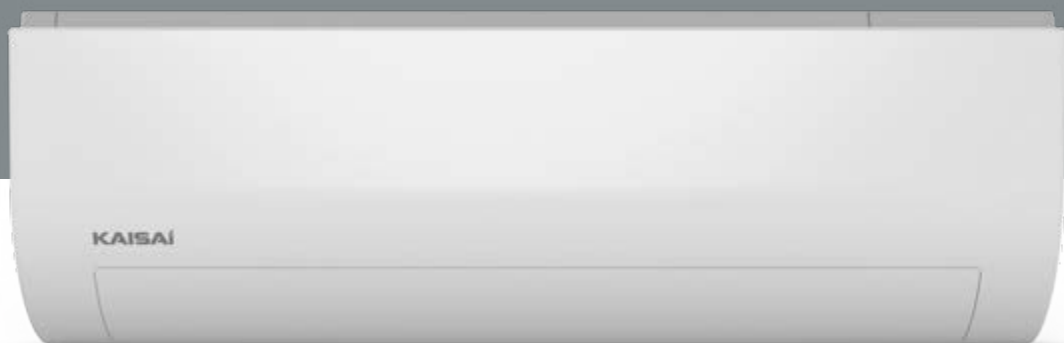



Features of **Kaisai One +**



Wide temperature range



Simple installation



Blinds settings memory



Refrigerant leakage indication



Operation at low outside temperatures



Remote control temperature sensor



Emergency use



Multi-functional remote control



Standby mode



Wi-Fi control



Heating function 8°C



Turbo mode



Self-cleaning evaporator



3D air supply



Sleep function



Timer



Automatic restart



Self-diagnosis



Cold-catalytic filter



BIO HEPA filter



Air ionization



Compressor and condensate tray heaters



Silver ion filter



Vitamin C filter



3M filter

Technical specification

MODEL	indoor unit		KRX-09PEGI	KRX-12PEGI	KRX-18PEGI	KRX-24PEGI
	outdoor unit		KRX-09PEGO	KRX-12PEGO	KRX-18PEGO	KRX-24PEGO
Capacity average (min÷max)	cooling	kW	2,6(1,0÷3,2)	3,5(1,4÷4,3)	5,3(3,4÷5,9)	7,0(2,1÷8,2)
	heating	kW	2,9(0,8÷3,4)	3,8(1,1÷4,4)	5,6(3,1÷5,9)	7,3(1,6÷8,2)
Energy class	cooling/heating		A+++ / A++	A+++ / A++	A++/A+	A++/A+
SEER	average	W/W	8,8	8,5	7,5	6,5
SCOP	average	W/W	4,6	4,6	4,0	4,0
Average power consumption (min÷max)	cooling	W	628(90÷1140)	1034(130÷1650)	1550(560÷2050)	2340(420÷3200)
	heating	W	666(110÷1080)	1027(160÷1560)	1500(780÷2000)	2130(300÷3100)
Average operating current (min÷max)	cooling	A	2,7(0,4÷4,9)	4,5(0,6÷7,2)	6,7(2,4÷9)	10,0(1,8÷13,9)
	heating	A	2,9(0,5÷4,7)	4,6(0,7÷6,8)	6,5(2,2÷8,8)	9,3(1,3÷13,5)
Air flow rate	indoor	m³/h	480/365/305	531/414/327	540/710/800	980/860/640
	outdoor	m³/h	2150	2200	2100	3500
Operating temp. cooling/heating	indoor	°C	17÷32/0÷30	17÷32/0÷30	17÷32/0÷30	17÷32/0÷30
	outdoor	°C	-15÷50/-25÷30	-15÷50/-25÷30	-15÷50/-25÷30	-15÷50/-25÷30
Sound pressure level	indoor	dB(A)	36,5/29/24/20	39/33/25/21	43,5/39/32/22	46/42/33/28
	outdoor	dB(A)	54,5	55,0	56,0	60,5
Net dimensions w/h/d	indoor	mm	805x302x193	805x302x193	964x325x222	1106x342x232
	outdoor	mm	765x555x303	765x555x303	805x554x330	890x673x342
Transport dimensions w/h/d	indoor	mm	875x375x290	875x375x290	1045x405x310	1195x420x320
	outdoor	mm	887x610x337	887x610x337	915x615x370	995x740x398
Net weight	indoor	kg	8,7	8,7	11,3	14,2
	outdoor	kg	26,7	26,7	33,5	43,9
Transport weight	indoor	kg	11,4	11,4	14,7	18,1
	outdoor	kg	29,1	29,1	36,1	46,9
Pipe diameter: liquid/gas		mm	6,35/9,52	6,35/9,52	6,35/12,7	9,52/15,9
Maximum installation length		m	25	25	30	50
Maximum height difference		m	10	10	20	25
Power supply	outdoor	V/Hz/Ph	220÷240/50/1	220÷240/50/1	220÷240/50/1	220÷240/50/1
Circuit breaker/fuse	outdoor	A	10	16	16	20
Power supply lines	outdoor	# of wires x mm²	3x1,5	3x1,5	3x2,5	3x2,5
Control lines	ind. - outd.	# of wires x mm²	5x1,5	5x1,5	5x1,5	5x1,5
Factory amount of refrigerant	up to 5 rm	kg	0,62	0,62	1,10	1,45
Additional amount of refrigerant	over 5 rm	g/m	12	12	12	24

* Additional electric heaters, compressor and condensate tray are required for heating operation at outdoor temperatures below -15°C.

59

Controllers

WIRELESS
REMOTE CONTROL



RG10B1

WIRELESS
REMOTE CONTROL



**RG66A1
(OPTIONAL)**

WIRED REMOTE
CONTROL



**KJR-120X2
(OPTIONAL)**

WIRED REMOTE
CONTROL



**CCM
(OPTIONAL)**



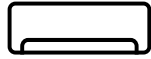

KWC-12/18 CGI

Care

With its filters and modern features, the Kaisai Care wall air conditioner ensures clean air in your home.

The air conditioner is equipped with dual filters to stop pollen and dust, absorb dust mites and remove unwanted odours from the air. The I-Clean function effectively removes dust and mould from the unit, prevents the growth of bacteria and keeps the interior clean. The use of UV lamp and sterilisation function allows to eliminate micro-organisms present in the air-conditioned room.

61

A⁺ | R32 | 

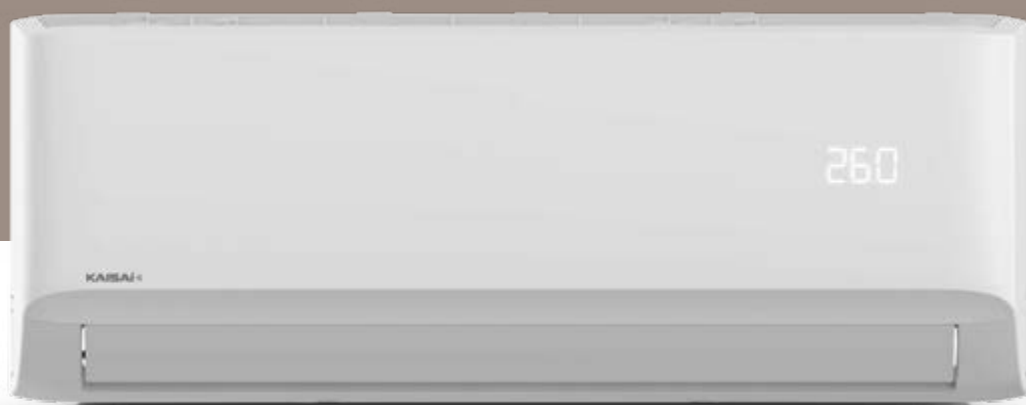



Features of **Kaisai Care**

Wide temperature range	High-density filter	Blinds settings memory	Refrigerant leakage indication	Wi-Fi control	Emergency use	Double sided installation	Standby mode	Heating function 8°C	UV lamp	Self-diagnosis	Operation at low outside temperatures
3D air supply	Sleep function	Eco	Timer	Automatic restart	Remote control temperature sensor	Turbo mode	Gear mode	Sterilisation at 56°C function	Double filtration	Smooth fan speed adjustment	
OPTIONAL	OPTIONAL	OPTIONAL	OPTIONAL								
Silver ion filter	Vitamin C filter	3M filter	Compressor and condensate tray heaters								

Technical specification

MODEL	indoor unit		KWC-12CGI	KWC-18CGI
	outdoor unit		KWC-12CGO	KWC-18CGO
Capacity average (min÷max)	cooling	kW	3,5(1,4÷4,3)	5,3(3,4÷5,9)
	heating	kW	3,8(1,1÷4,4)	5,6(3,1÷5,8)
Energy class	cooling/heating		A++/A+	A++/A+
SEER	average		W/W	7,0
SCOP	average		W/W	4,2
Average power consumption (min÷max)	cooling	W	1096(120÷1650)	1550(560÷2050)
	heating	W	1027(110÷1480)	1750(780÷2000)
Average operating current (min÷max)	cooling	A	4,8(0,5÷7,2)	6,7(2,4÷9,0)
	heating	A	4,5(0,5÷6,4)	7,6(3,4÷8,7)
Air flow rate	indoor	m ³ /h	530/400/350	800/600/500
	outdoor	m ³ /h	1850	2100
Operating temperature cooling/heating	indoor	°C	17÷32/0÷30	17÷32/0÷30
	outdoor	°C	-15÷50/-25÷24	-15÷50/-25÷24
Sound pressure level	indoor	dB(A)	37/32/22/21	41/37/31/20
	outdoor	dB(A)	55	57
Net dimensions w/h/d	indoor	mm	835/295/208	969/320/241
	outdoor	mm	720/495/270	874/554/330
Transport dimensions w/h/d	indoor	mm	905/355/290	1045/405/315
	outdoor	mm	835/540/300	915/615/370
Net weight	indoor	kg	8,7	11,2
	outdoor	kg	23,7	33,5
Transport weight	indoor	kg	11,5	14,6
	outdoor	kg	25,5	36,1
Pipe diameter: liquid/gas		mm	6,35/9,52	6,35/12,70
Maximum installation length		m	25	30
Maximum height difference		m	10	20
Power supply	outdoor	V/Hz/Ph	220÷240/50/1	220÷240/50/1
Circuit breaker/fuse	outdoor	A	10	16
Power supply lines	outdoor	# of wires x mm ²	3x1,5	3x1,5
Control lines	ind. - outd.	# of wires x mm ²	5x1,5	5x1,5
Factory amount of refrigerant	up to 5 rm	kg	0,65	1,10
Additional amount of refrigerant	over 5 rm	g/m	12	12

* Additional electric heaters, compressor and condensate tray are required for heating operation at outdoor temperatures below -15°C.

63

Controllers

WIRELESS
REMOTE CONTROL

RG10A1



WIRELESS
REMOTE CONTROL

**RG66A1
(OPTIONAL)**





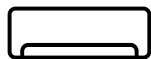

KGE 12 | 18 GRGI

geo

Geo units offer the highest energy efficiency class and modern air purification functions.

The Geo air conditioner series is the perfect combination of original design and top energy class A+++ in cooling mode and A+++ in heating mode. Thanks to the double filtration system and the air ionisation function, the device effectively cleans the air-conditioned room from dust, microbes and unwanted chemical substances. High comfort of use of the air conditioner is ensured by the Wi-Fi module as standard and the 3D air intake allowing for optimal air circulation and even temperature distribution in the room.

65

A⁺⁺⁺

R32





Features of Kaisai Geo



Wide temperature range



Simple installation



Blinds settings memory



Refrigerant leakage indication



Operation at low outside temperatures



Timer



Emergency use



Multi-functional remote control



Standby mode



Wi-Fi control



Heating function 8°C



Turbo mode



Self-cleaning evaporator



3D air supply



Sleep function



Automatic restart



Self-diagnosis



Remote control temperature sensor



Cold-catalytic filter



BIO HEPA filter



Air ionization



Compressor and condensate tray heaters



Silver ion filter



Vitamin C filter



3M filter

Technical specification

MODEL	indoor unit		KGE-12GRGI	KGE-18GRGI
	outdoor unit		KGE-12GRGO	KGE-18GRGO
Capacity average (min÷max)	cooling	kW	3,5(1,4÷4,3)	5,3(3,4÷5,9)
	heating	kW	3,8(1,1÷4,4)	5,6(3,1÷5,8)
Energy class	cooling/heating		A+++/A++	A++/A+
SEER	average		8,5	7,0
SCOP	average		4,6	4,0
Average power consumption (min÷max)	cooling	W	977(130÷1650)	1550(560÷2050)
	heating	W	977(160÷1560)	1500(780÷2000)
Average operating current (min÷max)	cooling	A	4,2(0,6÷7,2)	6,7(2,4÷9,0)
	heating	A	4,2(0,7÷6,8)	6,5(3,4÷8,7)
Air flow rate	indoor	m ³ /h	584/477/395	730/500/420
	outdoor	m ³ /h	2100	2200
Operating temperature cooling/heating	indoor	°C	17÷32/0÷30	17÷32/0÷30
	outdoor	°C	-15÷50/-25÷24	-15÷50/-25÷24
Sound pressure level	indoor	dB(A)	39,5/33/25/21	43/33,5/28/23
	outdoor	dB(A)	54,5	55,5
Net dimensions w/h/d	indoor	mm	802/297/189	965/319/215
	outdoor	mm	765/555/303	805/554/330
Transport dimensions w/h/d	indoor	mm	875/380/285	1045/410/305
	outdoor	mm	887/610/337	915/615/370
Net weight	indoor	kg	8,6	10,9
	outdoor	kg	26,7	33,5
Transport weight	indoor	kg	11,1	14,2
	outdoor	kg	29,1	36,1
Pipe diameter: liquid/gas		mm	6,35/9,52	6,35/12,70
Maximum installation length		m	25	30
Maximum height difference		m	10	20
Power supply	outdoor	V/Hz/Ph	220÷240/50/1	220÷240/50/1
Circuit breaker/fuse	outdoor	A	10	16
Power supply lines	outdoor	# of wires x mm ²	3x1,5	3x1,5
Control lines	ind. - outd.	# of wires x mm ²	5x1,5	5x1,5
Factory amount of refrigerant	up to 5 rm	kg	0,62	1,10
Additional amount of refrigerant	over 5 rm	g/m	12	12

* Additional electric heaters, compressor and condensate tray are required for heating operation at outdoor temperatures below -15°C.

67

Controllers

WIRELESS
REMOTE CONTROL



RG10B1

WIRELESS
REMOTE CONTROL



**RG66A
(OPTIONAL)**



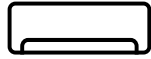

KSH-12HRHI

hot

A top-of-the-line energy efficient appliance with exceptionally high energy efficiency ratings.

Ideal solution in cold climate zones, allowing for efficient heating of rooms in a very wide range of outdoor temperatures – even down to -25°C.

Hot combines modern design with high comfort, which is ensured by Wi-Fi as standard, air ionisation, Eco, Gear and 3D air vent functions.

A⁺⁺ | R32 | 

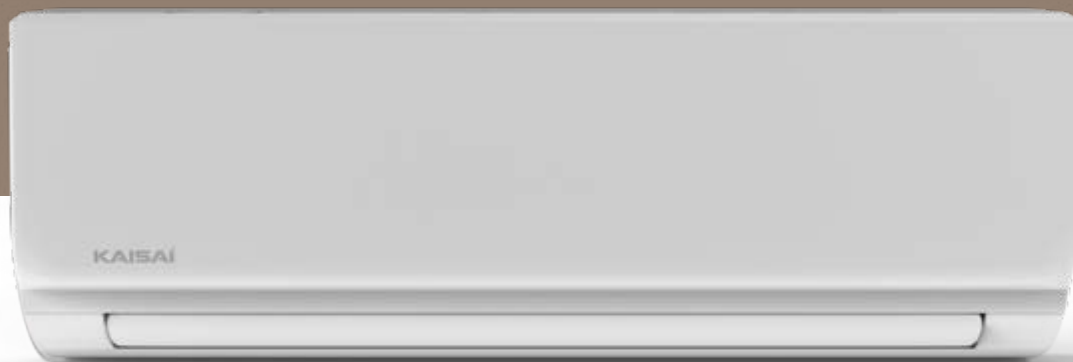



Features of **Kaisai Hot**

- | | | | | | | | | | | | | |
|------------------------|---------------------|------------------------|--------------------------------|---------------------------------------|-----------|-----------------------------------|---------------------------|-----------------------|----------------------|-------------------|-----------------------------|----------------|
| | | | | | | | | | | | | |
| Wide temperature range | High-density filter | Blinds settings memory | Refrigerant leakage indication | Operation at low outside temperatures | Timer | Emergency use | Double sided installation | Standby mode | Heating function 8°C | Air ionization | Smooth fan speed adjustment | Self-diagnosis |
| | | | | | | | | | | | | |
| 3D air supply | Sleep function | Eco | Wi-Fi control | Automatic restart | Gear mode | Remote control temperature sensor | Turbo mode | Cold-catalytic filter | BIO HEPA filter | Silver ion filter | Vitamin C filter | 3M filter |

Technical specification

MODEL	indoor unit	KSH-12HRHI	
	outdoor unit	KSH-12HRHO	
Capacity average (min÷max)	cooling	kW	3,5(0,9÷4,7)
	heating	kW	3,8(0,8÷5,6)
Energy class	cooling/heating		A+++/A++
SEER	average	W/W	8,5
SCOP	average	W/W	4,6
Average power consumption (min÷max)	cooling	W	879(60÷1590)
	heating	W	929(130÷2130)
Average operating current (min÷max)	cooling	A	3,8(0,3÷7,0)
	heating	A	4,0(0,6÷9,4)
Air flow rate	indoor	m³/h	520/370/310
	outdoor	m³/h	2150
Operating temperature cooling/heating	indoor	°C	16÷32/0÷30
	outdoor	°C	-15÷50/-25÷24
Sound pressure level	indoor	dB(A)	39/30/24
	outdoor	dB(A)	57,0
Net dimensions w/h/d	indoor	mm	835x295x208
	outdoor	mm	765x555x303
Transport dimensions w/h/d	indoor	mm	905x355x290
	outdoor	mm	887x610x337
Net weight	indoor	kg	8,7
	outdoor	kg	29,6
Transport weight	indoor	kg	11,3
	outdoor	kg	32
Pipe diameter: liquid/gas		mm	6,35/9,52
Maximum installation length		m	25
Maximum height difference		m	10
Power supply	outdoor	V/Hz/Ph	220-240/50/1
Circuit breaker/fuse	outdoor	A	10
Power supply lines	outdoor	# of wires x mm²	3x1,5
Control lines	ind. - outd.	# of wires x mm²	5x1,5
Factory amount of refrigerant	up to 5 rm	kg	0,7
Additional amount of refrigerant	over 5 rm	g/m	12

71

Controllers

WIRELESS
REMOTE CONTROL

RG10A1



WIRED REMOTE
CONTROL

KJR-120X2
(OPTIONAL)



WIRED REMOTE
CONTROL

CCM
(OPTIONAL)





72

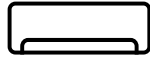

KBA-12H29RI

#290

The first wall-mounted air conditioner in the Kaisai product range to use the fully eco-friendly refrigerant R290, with a very low GWP and virtually zero negative impact on the environment.

Thanks to its properties, R290 has been awarded the most renowned certificate given to ecological products – Blue Angel. In addition to its high energy rating, R290 is characterised by a number of useful features such as: Wi-Fi as a standard, 3D ventilation, Bio HEPA air filters and cold-catalytic filter.

73

A⁺⁺ | R290 | 

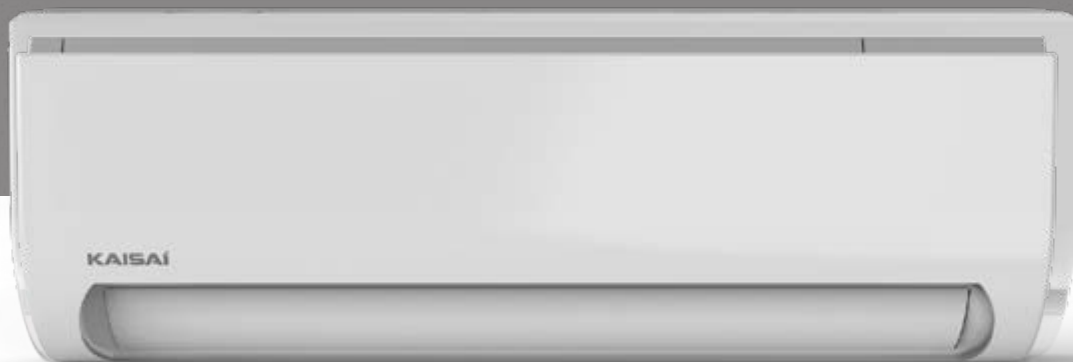



Features of **Kaisai #290**



Wide temperature range



Simple installation



Blinds settings memory



Refrigerant leakage indication



Operation at low outside temperatures



Remote control temperature sensor



Emergency use



Wi-Fi control



Standby mode



Heating function 8°C



Self-cleaning evaporator



3D air supply



Sleep function



Timer



Automatic restart



Self-diagnosis



Turbo mode



Cold-catalytic filter



BIO HEPA filter



Silver ion filter



Vitamin C filter



3M filter

OPTIONAL

OPTIONAL

OPTIONAL

Technical specification

MODEL	indoor unit		KBA-12H29RI
	outdoor unit		KBA-12H29RO
Capacity average (min÷max)	cooling	kW	3,5(1,4÷4,3)
	heating	kW	3,8(1,1÷4,4)
Energy class	cooling/heating		A+++/A++
SEER	average	W/W	8,5
SCOP	average	W/W	4,6
Average power consumption (min÷max)	cooling	W	977(130÷1650)
	heating	W	1270(160÷1560)
Average operating current (min÷max)	cooling	A	4,2(0,6÷7,2)
	heating	A	5,2(0,7÷6,8)
Air flow rate	indoor	m ³ /h	530/421/335
	outdoor	m ³ /h	3000
Operating temperature cooling/heating	indoor	°C	17÷32/0÷30
	outdoor	°C	-15÷50/-15÷30
Sound pressure level	indoor	dB(A)	40/35/27/21
	outdoor	dB(A)	56,0
Net dimensions w/h/d	indoor	mm	805x302x193
	outdoor	mm	805x554x330
Transport dimensions w/h/d	indoor	mm	875x375x290
	outdoor	mm	915x615x370
Net weight	indoor	kg	8,5
	outdoor	kg	33,9
Transport weight	indoor	kg	11,3
	outdoor	kg	36,5
Pipe diameter: liquid/gas		mm	6,35/9,52
Maximum installation length		m	25
Maximum height difference		m	10
Power supply	outdoor	V/Hz/Ph	220-240/50/1
Circuit breaker/fuse	outdoor	A	10
Power supply lines	outdoor	# of wires x mm ²	3x1,5
Control lines	ind. - outd.	# of wires x mm ²	5x1,5
Factory amount of refrigerant	up to 5 rm	kg	0,38
Additional amount of refrigerant	over 5 rm	g/m	10

75

Controllers

WIRELESS
REMOTE CONTROL

RG10B1



R290
REFRIGERANT

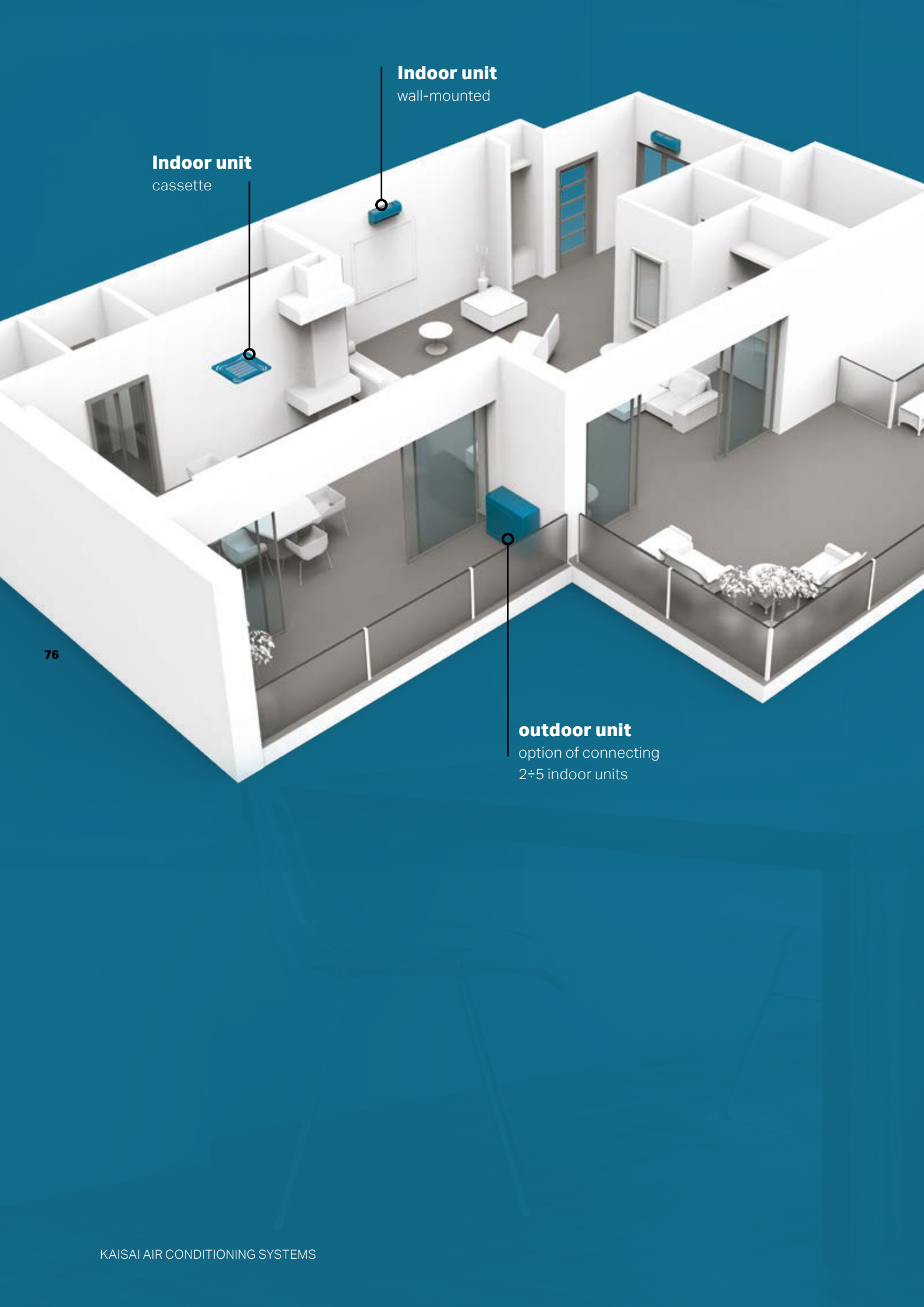

Indoor unit
cassette

Indoor unit
wall-mounted

outdoor unit
option of connecting
2÷5 indoor units



Multi split systems

77

Multi Split air conditioners are extremely energy-efficient units. The system allows the connection from 2 to 5 Fly or wall units, One+ Kompakt cassette or duct units to one (external) unit.

Each of the indoor units operates individually, has the option of independently adjusting the temperature and adjusting the power to the users' needs. When buying a Multi Split air conditioner, it is important to select the cooling capacity needed for each room in which the wall or cassette air conditioner will be placed.

The selected units are installed in the rooms and at the very end, each of the air conditioners is connected to a pre-installed single large unit (outdoor unit). This way, there is no need to install an indoor and an outdoor unit for each room.

indoor units



KWX 09 | 12 | 18 | 24 HRGI

WI-FI AS A STANDARD

MODEL			KWX-09HRGI	KWX-12HRGI	KWX-18HRGI	KWX-24HRGI
Power supply	V/Hz/Ph		220÷240/50/1	220÷240/50/1	220÷240/50/1	220÷240/50/1
Capacity	cooling	kW	2,6	3,5	5,3	7
	heating	kW	2,9	3,8	5,6	7,3
Air flow rate	m³/h		466/360/325	540/430/314	840/680/540	980/817/662
Sound pressure level	(high/medium/low)	dB(A)	38,5/32/25/21	40,5/34,5/25/21	42,5/36/26/20	45/40,5/36/30
Dimensions w/h/d	net	mm	805/285/194	805/285/194	957/302/213	1040/327/220
	transport	mm	870/365/270	870/365/270	1035/385/295	1120/405/315
Weight	net	kg	7,6	7,6	10,0	12,3
	transport	kg	9,7	9,8	13,0	15,8
Pipe diameter	liquid	mm	6,35	6,35	6,35	9,52
	gas	mm	9,52	9,52	12,70	15,90

78

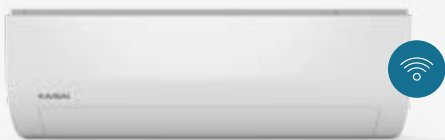

KRX 09 | 12 | 18 | 24 PEGI

WI-FI AS A STANDARD

MODEL			KRX-09PEGI	KRX-12PEGI	KRX-18PEGI	KRX-24PEGI
Power supply	V/Hz/Ph		220÷240/50/1	220÷240/50/1	220÷240/50/1	220÷240/50/1
Capacity	cooling	kW	2,6	3,5	5,3	7
	heating	kW	2,9	3,8	5,6	7,3
Air flow rate	m³/h		480/365/305	531/414/327	540/710/800	980/860/640
Sound pressure level	(high/medium/low)	dB(A)	36,5/29/24/20	39/33/25/21	43,5/39/32/22	46/42/33/28
Dimensions w/h/d	net	mm	805x302x193	805x302x193	964x325x222	1106x342x232
	transport	mm	875x375x290	875x375x290	1045x405x310	1195x420x320
Weight	net	kg	8,7	8,7	11,3	14,2
	transport	kg	11,4	11,4	14,7	18,1
Pipe diameter	liquid	mm	6,35	6,35	6,35	9,52
	gas	mm	9,52	9,52	12,70	15,90



KCA3I-09HRG32X | KCA3U 12 | 18 HRG32X

MODEL			KCA3I-09HRG32X	KCA3U-12HRG32X	KCA3U-18HRG32X
Power supply		V/Hz/Ph	220÷240/50/1	220÷240/50/1	220÷240/50/1
Capacity	cooling	kW	2,6	3,5	5,3
	heating	kW	2,8	3,8	5,6
Air flow rate		m³/h	580/500/450	620/510/420	720/620/500
Sound pressure level	(high/medium/low)	dB(A)	38/33/29	41/36/33/25,5	43/39,5/35,5/29
Dimensions w/h/d	net	mm	570/260/570	570/260/570	570/260/570
	transport	mm	662/317/662	662/317/662	662/317/662
Dimensions w/h/dpanel	net	mm	647/50/647	647/50/647	647/50/647
	transport	mm	715/123/715	715/123/715	715/123/715
Weight	net	kg	14,5/2,5	16,0/2,5	16,3/2,5
	transport	kg	17,3/4,5	20,4/4,5	20,6/4,5
Pipe diameter	liquid	mm	6,35	6,35	6,35
	gas	mm	9,52	9,52	12,70

79



KTI-18HWG32X

MODEL			KTI-18HWG32X
Power supply		V/Hz/Ph	220÷240/50/1
Capacity	cooling	kW	5,3
	heating	kW	5,6
Air flow rate		m³/h	911/706/515
Sound pressure level	(high/medium/low)	dB(A)	41/38/34/26
Available compression ratio	factory / max.	Pa	25/100
Dimensions w/h/d	net	mm	880/210/674
	transport	mm	1070/280/725
Weight	net	kg	24,4
	transport	kg	29,6
Pipe diameter	liquid	mm	6,35
	gas	mm	12,70

indoor units configuration table

The table shows possible options for connecting indoor units of different capacities to outdoor units. The figures in the table correspond to the capacity of the units expressed in thousands of BTU/h.

K2OE-18HFN32H

1 UNIT	2 UNITS
9	9+9
12	9+12
18	12+12

K30A-27HFN32H

1 UNIT	2 UNITS	3 UNITS		
9	9+9	12+12	9+9+9	12+12+12
12	9+12	12+18	9+9+12	
18	9+18		9+12+12	

K4OE-28HFN32H

1 UNIT	2 UNITS	3 UNITS	4 UNITS
9	9+9	12+12	9+9+9
12	9+12	12+18	9+12+12
18	9+18	18+18	9+9+18
24	9+24	12+24	12+12+12

K4OB-36HFN32H

1 UNIT	2 UNITS	3 UNITS	4 UNITS
9	9+9	12+24	9+9+9
12	9+12	24+9	9+18+18
18	9+18	24+12	9+12+24
24	12+12	9+9+24	12+12+12
	12+18	9+12+12	24+9+9
	18+18	9+12+18	24+12+12

K5OE-42HFN32H

1 UNIT	2 UNITS	3 UNITS		
9	9+9	12+12	9+9+9	9+12+12
12	9+12	12+18	9+12+12	9+12+18
18	9+18	12+24	9+9+18	9+12+24
24	9+24	18+18	9+9+24	9+18+18

4 UNITS			5 UNITS		
9+9+9+9	9+9+12+18	12+12+12+12	9+9+9+9+9		
9+9+9+12	9+9+12+24	12+12+12+18	9+9+9+9+12		
9+9+9+18	9+9+18+24		9+9+9+9+18		
9+9+9+24	9+12+12+12		9+9+9+12+12		
9+9+12+12	9+12+12+18		9+9+9+12+18		

outdoor units

Technical specification

MODEL	outdoor unit		K20E-18HFN32H	K30A-27HFN32H	K40E-28HFN32H	K40B-36HFN32H	K50E-42HFN32H
Capacity average (min÷max)	cooling	kW	5,3(2,3÷5,7)	7,9(3,2÷8,2)	8,2(2,0÷9,8)	10,6(2,0÷12,7)	12,3(3,0÷12,3)
	heating	kW	5,6(2,4÷5,7)	8,2(2,3÷8,5)	8,8(2,4÷10,6)	10,8(2,3÷13,0)	12,3(3,5÷12,3)
Energy class	cooling/heating		A++/A+	A++/A+	A++/A	A++/A	A++/A
SEER	average	W/W	6,1	6,1	6,1	6,2	6,1
SCOP	average	W/W	3,8	4,0	3,8	3,8	3,5
Average power consumption (min÷max)	cooling	W	1635(690÷2000)	2450(290÷3100)	2540(890÷3180)	3270(1140÷4090)	3810(280÷4650)
	heating	W	1500(600÷1780)	2210(370÷2900)	2200(770÷2750)	2760(970÷3450)	3300(650÷3800)
Average operating current (min÷max)	cooling	A	7.3(3.2÷9.0)	11.2(2.0÷13.5)	11.3(3.9÷14.1)	14.3(5.1÷18.2)	16(1.4÷20.7)
	heating	A	6.6(2.80÷7.95)	10.1(2.4÷13)	9.8(3.4÷12.2)	12.1(4.3÷15.3)	14.6(3.0÷16.6)
Air flow rate		m³/h	2100	3000	3800	4000	3850
Operating temperature cooling/heating		°C	-15+50/-15+24	-15+50/-15+24	-15+50/-15+24	-15+50/-15+24	-15+50/-15+24
Sound pressure level		dB(A)	54	58	61.5	63	64
Net dimensions w/h/d		mm	805/554/330	890/673/342	946/810/410	946/810/410	946/810/410
Transport dimensions w/h/d		mm	915/615/370	1030/750/438	1090/875/500	1090/875/500	1090/875/500
Net weight		kg	35,0	48,0	62,1	68,8	74,1
Transport weight		kg	38	51,8	67,7	75,6	79,5
Pipe diameter: liquid/gas		mm	2x 6,35/9,52	3x 6,35/9,52	3x 6,35/9,52 + 1x 6,35/12,7	3x 6,35/9,52 + 1x 6,35/12,7	4x 6,35/9,52 + 1x 6,35/12,7
Maximum installation length		m	40	60	80	80	80
Max. installation length for 1 indoor unit		m	25	30	35	35	35
Maximum height difference		m	15	15	15	15	15
Power supply		V/Hz/Ph	220-240/50/1	220-240/50/1	220-240/50/1	220-240/50/1	220-240/50/1
Circuit breaker/fuse		A	16	20	25	25	25
Power supply lines		# of wires x mm²	3x2,5	3x2,5	3x4,0	3x4,0	3x4,0
Control lines			4x1,5	4x1,5	4x1,5	4x1,5	4x1,5
Factory	up to 5 m	kg	1,25	1,85	2,10	2,10	2,90
Additional amount of refrigerant	over 5 m	g/m	12 (over 15 m of installation)	12 (over 22,5 m of installation)	12 (over 30 m of installation)	12 (over 30 m of installation)	12 (over 37,5 m of installation)

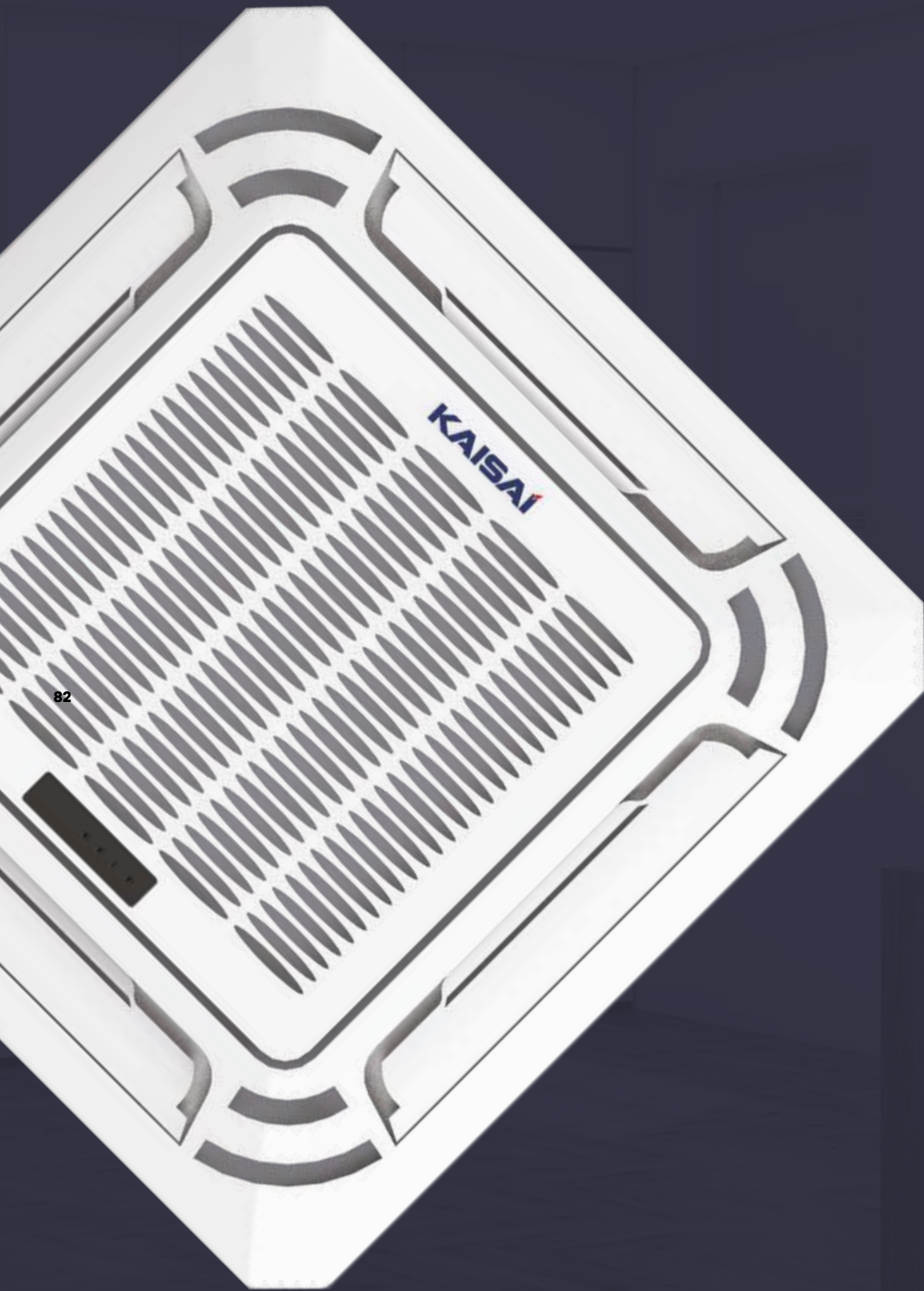

82

floor

floor and ceiling

cassette

duct

condensing units

Commercial air conditioners

83

Commercial air conditioning systems combine efficient operation with a wide range of solutions for offices, conference rooms, hotels and other rooms that require efficient air conditioning.

Depending on the area and purpose of the facility, as well as the installation possibilities, we can apply floor, floor/ceiling, cassette, duct, or condensing units.



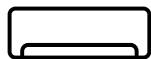

KFS-48HRG32X

kfs

The floor air conditioner is used in large rooms, such as stores, showrooms, restaurants and airport halls.

The KFS air conditioner is distinguished by an elegant and intuitive control panel, a functional wireless remote control with temperature sensor and energy saving technology, allowing the unit to operate in economy mode. The comfort of use is ensured by practical functions of the air conditioner, such as: 3D airflow for uniform temperature distribution in the room and the temperature sensor built in the remote control (thanks to which the temperature is measured where the user is located, and the operation of the air conditioner is adjusted to the actual conditions in the room). The device can be used in rooms of up to approx. 120-140 m².

A⁺ | R32



85



Features of **Kaisai kfs**



Wide temperature range



3D air supply



Automatic blinds (swing)



Refrigerant leakage indication



Cold air control



Remote control temperature sensor



Sleep function



Timer



Automatic restart



Self-diagnosis



Operation at low outside temperatures

OPTIONAL



Silver ion filter

OPTIONAL



Vitamin C filter

OPTIONAL



3M filter

Technical specification

MODEL	jedn. wewn.	KFS-48HRG32X	
	jedn. zewn.	KOE30U-48HFN32X	
Capacity average (min÷max)	cooling	kW	14,1(3,5÷15,7)
	heating	kW	16,1(4,1÷17,9)
Energy class	cooling/heating		A++/A+
SEER	average	W/W	6,1
SCOP	average	W/W	4
Average power consumption (min÷max)	cooling	W	4950(900÷5950)
	heating	W	5100(1000÷6200)
Average operating current (min÷max)	cooling	A	8,0(1,9÷10,3)
	heating	A	8,5(1,6÷10,5)
Air flow rate	indoor	m³/h	2413/2222/2027
	outdoor	m³/h	7500
Operating temperature cooling/heating	indoor	°C	17÷32/0÷30
	outdoor	°C	-15÷50/-15÷24
Sound pressure level	indoor	dB(A)	53/49/47
	outdoor	dB(A)	63,5
Net dimensions w/h/d	indoor	mm	629/1935/456
	outdoor	mm	952/1333/415
Transport dimensions w/h/d	indoor	mm	750/2055/575
	outdoor	mm	1095/1480/495
Net weight	indoor	kg	59,0
	outdoor	kg	103,7
Transport weight	indoor	kg	77,0
	outdoor	kg	118,3
Pipe diameter: liquid/gas		mm	9,52/15,9
Maximum installation length		m	75
Maximum height difference		m	30
Power supply	outdoor		380-420/50/3
Circuit breaker/fuse	outdoor	A	16
Power supply lines	outdoor	# of wires x mm²	5x2,5
Control lines	ind. - outd.		4 x 1,5
Factory amount of refrigerant	up to 5 rm	kg	2,9
Additional amount of refrigerant	over 5 rm	g/m	24
Outer diameter of condensate drain		mm	25

Controllers

WIRELESS
REMOTE CONTROL

RG10B





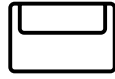

KUE 18|24|36|48|55 HRG32X

kue

Universal floor/ceiling air conditioners, which are perfect for rooms without false ceilings, among others.

They are characterised by a three-dimensional air flow thanks to the automatic control of the blinds. This ensures optimum air circulation and even temperature distribution. The timer allows you to set a time for the automatic activation and deactivation of the air conditioner. To minimise the feeling of unpleasant, cold air, the air conditioner starts in heating mode and automatically reduces the fan speed – until the heat exchanger heats up.































89

A⁺ | **R32**





Features of **Kaisai kue**

- | | | | | | | | | | | | |
|---|---|---|---|---|---|---|---|--|---|---|---|
|  |  |  |  |  |  |  |  |  |  |  |  |
| Blinds settings memory | Turbo mode | Double sided installation | Refrigerant leakage indication | Built-in condensate pump | Quiet operation | Alarm port | Emergency use | Timer | Automatic restart | Naview 3D | Compressor and condensate tray heaters |
|  |  |  |  |  |  |  |  |  |  |  |  |
| Twin combination | Fresh air | On-off port | Gear mode | The Eco Mode | Sleep function | Heating function 8°C | Self-cleaning evaporator | Cold air control | Remote control temperature sensor | Smooth fan speed adjustment | Operation at low outside temperatures |
| OPTIONAL | OPTIONAL | OPTIONAL | OPTIONAL | OPTIONAL | OPTIONAL | | | | | | |
|  |  |  |  |  |  | | | | | | |
| Central controller | Wi-Fi control | Wired controller | Silver ion filter | Vitamin C filter | 3M filter | | | | | | |

Technical specification

MODEL	jedn. wewn.		KUE-18HRG32X	KUE-24HRG32X	KUE-36HRG32X	KUE-36HRG32X	KUE-48HRG32X	KUE-55HRG32X
	jedn. zewn.		KOX330-18HF-N32X	KOX430-24HF-N32X	KOD30U-36HFJ32X	KOD30U-36HF-N32X	KOE30U-48HF-N32X	KOE30U-55HF-N32X
Capacity average (min÷max)	cooling	kW	5,3 (2,7÷5,9)	7,0 (3,2÷7,8)	10,6 (2,7÷11,4)	10,6 (2,7÷11,8)	14,1 (3,5÷15,2)	15,8 (4,1÷16,7)
	heating	kW	5,6 (2,4÷6,3)	7,6 (2,7÷8,3)	11,7 (2,8÷12,8)	11,7 (2,8÷12,8)	16,1 (4,1÷17,0)	18,2 (4,4÷19,6)
Energy class	cooling/heating		A++/A+	A++/A+	A++/A+	A++/A+	A++/A+	A++/A+
SEER	average	W/W	6,2	6,1	6,2	6,4	6,1	6,1
SCOP	average	W/W	4,0	4,0	4,0	4,1	4,0	4,0
Avg. power consumption (min÷max)	cooling	W	1450 (670÷2027)	2300 (747÷2930)	3900 (900÷4250)	40000 (890÷4300)	5000 (900÷5950)	5650 (1100÷6650)
	heating	W	1500 (540÷1640)	2050 (650÷2850)	3350 (800÷3950)	3350 (780÷3950)	5100 (1000÷6050)	6050 (1050÷7100)
Avg. operating current (min÷max)	cooling	A	6,0 (3,2÷9,0)	10,5 (3,9÷13,1)	17,0 (4,2÷19,0)	6,3 (1,4÷6,8)	8,8 (1,9÷10,3)	9,7 (3,2÷11,5)
	heating	A	6,6 (2,7÷7,3)	9,5 (3,5÷12,7)	15,0 (3,5÷17,5)	5,4 (1,3÷6,2)	8,9 (2,1÷10,5)	10,5 (2,2÷12,0)
Air flow rate	indoor	m³/h	958/839/723	1192/1023/853	1955/1728/1504	1955/1728/1504	2100/1850/1600	2200/1950/1650
	outdoor	m³/h	2200	3500	4000	4000	7500	7500
Operating temp. cooling/heating	indoor	°C	16÷32/0÷30	16÷32/0÷30	16÷32/0÷30	16÷32/0÷30	16÷32/0÷30	16÷32/0÷30
	outdoor	°C	-15+50/-15+24	-15+50/-15+24	-15+50/-15+24	-15+50/-15+24	-15+50/-15+24	-15+50/-15+24
Sound pressure level	indoor	dB(A)	43,5/41/36,5/24	49/46/43/32	50/48,5/44/37	50/48,5/44/37	53/50/45/36	54/50,5/46,5/38
	outdoor	dB(A)	56	60	63	63	63,5	64
Net dimensions w/h/d	indoor	mm	1068/675/235	1068/675/235	1650/675/235	1650/675/235	1650/675/235	1650/675/235
	outdoor	mm	805/554/330	890/673/342	946/810/410	946/810/410	952/1333/415	952/1333/415
Transp. dimensions w/h/d	indoor	mm	1145/755/318	1145/755/318	1725/755/318	1725/755/318	1725/755/318	1725/755/318
	outdoor	mm	915/615/370	995/740/398	1090/885/500	1090/885/500	1095/1480/495	1095/1480/495
Net weight	indoor	kg	28,0	28,0	41,5	41,5	41,7	42,3
	outdoor	kg	26,6	43,9	66,9	80,5	103,7	107,0
Transport weight	indoor	kg	33,1	33,3	48,0	48,0	48,5	49,2
	outdoor	kg	29,0	46,9	71,5	85,0	118,3	121,2
Pipe diameter: liquid/gas	mm		6,35/12,7	9,52/15,9	9,52/15,9	9,52/15,9	9,52/15,9	9,52/15,9
Maximum installation length	m		30	50	75	75	75	75
Maximum height difference	m		20	25	30	30	30	30
Power supply	outdoor	V/Hz/Ph	220÷240/50/1	220÷240/50/1	220÷240/50/1	380÷420/50/3	380÷420/50/3	380÷420/50/3
Circuit breaker/fuse	outdoor	A	16	20	25	16	16	16
Power supply lines	outdoor	# of wires	3x2,5	3x2,5	3x4,0	5x2,5	5x2,5	5x2,5
Control lines	ind. - outd.	x mm²	4x1,5	4x1,5	4x1,5	4x1,5	4x1,5	4x1,5
Factory amount of	up to 5 rm	kg	1,15	1,5	2,4	2,4	2,9	3,0
Additional refrigerant	over 5 rm	g/m	12	24	24	24	24	24
Outer diameter of condensate drain	mm		25	25	25	25	25	25

Controllers

WIRELESS
REMOTE CONTROL



RG10A

WIRED REMOTE
CONTROL



KJR-120X2
(OPTIONAL)

WIRED REMOTE
CONTROL



CCM
(OPTIONAL)



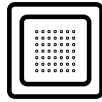

KCA3U 12 | 18 HRG32X

kca

Cassette air conditioners are ideal for offices, conference rooms and other rooms requiring efficient air conditioning.

Kompakt cassette air conditioners are equipped with an indoor unit with a quiet fan and a peripheral airflow. They are characterised by high performance and high user comfort. They have a fresh air supply function and the option of connecting an additional supply air duct to the adjacent room.

93



A⁺

R32



Features of **Kaisai kca**



Blinds settings memory



Fresh air



360° air supply



Refrigerant leakage indication



Sleep function



Quiet operation



Emergency use



Timer



Automatic restart



Alarm port



Self-diagnosis



Operation at low outside temperatures



The Eco Mode



Turbo mode



Gear mode



Heating function 8°C



Built-in condensate pump



Remote control temperature sensor



Temperature compensation



Cold air control



On-off port



Self-cleaning evaporator



Smooth fan speed adjustment



Compressor and condensate tray heaters



Central controller



Wi-Fi control



Wired controller

Technical specification

MODEL	indoor unit		KCA3U-12HRG32X	KCA3U-18HRG32X
	outdoor unit		KOX230-12HFN32X	KOX330-18HFN32X
Capacity average (min÷max)	cooling	kW	3,5 (0,8÷4,1)	5,3 (2,9÷5,6)
	heating	kW	3,8 (0,5÷4,3)	5,6 (2,4÷6,1)
Energy class	cooling/heating		A++/A+	A++/A+
SEER	average		W/W	6,6
SCOP	average		W/W	4,1
Average power consumption (min÷max)	cooling	W	1010 (168÷1434)	1633 (720÷2088)
	heating	W	1019 (124÷1376)	1540 (700÷1930)
Average operating current (min÷max)	cooling	A	4,4 (1,3÷6,3)	7,2 (3,2÷9,2)
	heating	A	4,7 (1,0÷6,1)	6,8 (3,1÷8,5)
Air flow rate	indoor	m³/h	620/510/420	720/620/500
	outdoor	m³/h	2100	2200
Operating temperature cooling/heating	indoor	°C	16÷32/0÷30	16÷32/0÷30
	outdoor	°C	-15+50/-15+24	-15+50/-15+24
Sound pressure level	indoor	dB(A)	41/36/33/25,5	43/39,5/35,5/29
	outdoor	dB(A)	53,6	56
Net dimensions w/h/d	indoor	mm	570/260/570	570/260/570
	outdoor	mm	765/555/303	805/554/330
	panel	mm	647/50/647	647/50/647
Transport dimensions w/h/d	indoor	mm	662/317/662	662/317/662
	outdoor	mm	887/610/337	915/615/370
	panel	mm	715/123/715	715/123/715
Net weight	indoor	kg	16,0/2,5	16,3/2,5
	outdoor	kg	26,6	32,5
Transport weight	indoor	kg	20,4/4,5	20,6/4,5
	outdoor	kg	29,0	35,2
Pipe diameter: liquid/gas		mm	6,35/9,52	6,35/12,70
Maximum installation length		m	25	30
Maximum height difference		m	10	20
Power supply	outdoor	V/Hz/Ph	220÷240/50/1	220÷240/50/1
Circuit breaker/fuse	outdoor	A	16	16
Power supply lines	outdoor	# of wires x mm²	3x2,5	3x2,5
Control lines	ind. - outd.	# of wires x mm²	4x1,5	4x1,5
Factory amount of refrigerant	up to 5 rm	kg	0,72	1,15
Additional amount of refrigerant	over 5 rm	g/m	12	12
External diameter of condensate drain		mm	25	25

95

Controllers

WIRELESS
REMOTE CONTROL

RG10A



WIRED REMOTE
CONTROL

**KJR-120X2
(OPTIONAL)**



WIRED REMOTE
CONTROL

**KJR12B
(OPTIONAL)**



WIRED REMOTE
CONTROL

**CCM
(OPTIONAL)**





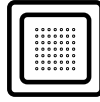

KCD 24 | 36 | 48 | 55 HRG32X

kcd

Air conditioners that are ideal for suspended ceilings with particularly limited technical space.

The air gap area has been increased by 23%, making the air conditioner quieter and more efficient. Compared to the previous model, the height of the condensate pump lift has also been increased to 100 cm and its placement outside the unit makes maintenance or potential replacement much easier. A new feature is the Wi-Fi port built into the air conditioner, allowing you to control the unit via an app on your phone or tablet.

97

































A⁺

R32



Features of **Kaisai kcd**

- | | | | | | | | | | | | |
|---|---|---|---|---|---|---|---|--|---|---|---|
|  |  |  |  |  |  |  |  |  |  |  |  |
| Blinds settings memory | Fresh air | 360° air supply | Refrigerant leakage indication | Sleep function | Cold air control | Emergency use | Timer | Automatic restart | Alarm port | Self-diagnosis | Operation at low outside temperatures |
|  |  |  |  |  |  |  |  |  |  |  |  |
| Twin combination | Turbo mode | Gear mode | The Eco Mode | On-off port | Quiet operation | Temperature compensation | Remote control temperature sensor | Built-in condensate pump | Self-cleaning evaporator | Smooth fan speed adjustment | Compressor and condensate tray heaters |
|  |  |  |  |  |  | | | | | | |
| Heating function 8°C | Wi-Fi control | Function Vane | Breeze Away function | Central controller | Wired controller | | | | | | |

Technical specification

MODEL	jedn. wewn.		KCD-24HRG32X	KCD-36HRG32X	KCD-36HRG32X	KCD-48HRG32X	KCD-55HRG32X
	jedn. zewn.		KOX430-24HF-N32X	KOD30U-36HFJ32X	KOD30U-36HF-N32X	KOE30U-48HF-N32X	KOE30U-55HF-N32X
Capacity average (min÷max)	cooling	kW	7,0(3,3÷7,9)	10,6(2,7÷11,4)	10,6(2,7÷11,4)	14,1(3,5÷15,8)	15,2(4,1÷16,7)
	heating	kW	7,6(2,8÷8,9)	11,1(2,8÷12,0)	11,1(2,8÷12,7)	16,1(4,1÷17,3)	18,2(4,4÷19,9)
Energy class	cooling/heating		A++/A+	A++/A+	A++/A+	A++/A+	A++/A+
SEER	average	W/W	6,2	6,7	6,4	6,1	6,3
SCOP	average	W/W	4,0	4,0	4,0	4,0	4,0
Average power consumption (min÷max)	cooling	W	2320 (780÷2748)	3950 (900÷4200)	4000 (890÷4150)	4650 (800÷5900)	5000 (980÷6200)
	heating	W	1900 (610÷2700)	3000 (800÷3950)	3000 (780÷4000)	4580 (900÷5500)	5550 (1020÷6700)
Average operating current (min÷max)	cooling	A	10,2(4,2÷12,0)	17,5 (4,2÷18,5)	6,5 (1,4÷6,5)	8,1 (1,8÷10,2)	8,6 (2,1÷10,7)
	heating	A	8,5 (3,6÷12,1)	13,5 (3,5÷17,5)	5,0 (1,3÷6,4)	8,0 (1,9÷9,5)	9,6 (2,1÷10,7)
Air flow rate	indoor	m ³ /h	1300/1140/1000	1700/1550/1380	1800/1600/1400	1970/1780/1580	2000/1850/1650
	outdoor	m ³ /h	3500	4000	4000	7500	7500
Operating temp. cooling/heating	indoor	°C	16÷32/0÷30	16÷32/0÷30	16÷32/0÷30	16÷32/0÷30	16÷32/0÷30
	outdoor	°C	-15+50/-15+24	-15+50/-15+24	-15+50/-15+24	-15+50/-15+24	-15+50/-15+24
Sound pressure level	indoor	dB(A)	45,5/42,5/39,5/27	50/47,5/44,5/39	50/47,5/44,5/39	51/48,5/46,5/37,5	53/50,5/48/40
	outdoor	dB(A)	60	63	63	63,5	64
Net dimensions w/h/d	indoor	mm	830/205/830	830/245/830	830/245/830	830/287/830	830/287/830
	outdoor	mm	950/55/950	950/55/950	950/55/950	950/55/950	950/55/950
	panel	mm	890/673/342	946/810/410	946/810/410	952/1333/415	952/1333/415
Transport dimensions w/h/d	indoor	mm	910/250/910	910/290/910	910/290/910	910/330/910	910/330/910
	outdoor	mm	1035/90/1035	1035/90/1035	1035/90/1035	1035/90/1035	1035/90/1035
	panel	mm	995/740/398	1090/885/500	1090/885/500	1095/1480/495	1095/1480/495
Net weight	indoor	kg	21,6/6,0	27,2/6,0	27,2/6,0	29,3/6,0	29,3/6,0
	outdoor	kg	43,9	66,9	80,5	103,7	107,0
Transport weight	indoor	kg	25,4/9,0	31,2/9,0	31,2/9,0	33,5/9,0	33,5/9,0
	outdoor	kg	46,9	71,5	85,0	118,3	121,2
Pipe diameter: liquid/gas		mm	9,52/15,9	9,52/15,9	9,52/15,9	9,52/15,9	9,52/15,9
Maximum installation length		m	50	75	75	75	75
Maximum height difference		m	25	30	30	30	30
Power supply	outdoor	V/Hz/Ph	220÷240/50/1	220÷240/50/1	380÷420/50/3	380÷420/50/3	380÷420/50/3
Circuit breaker/fuse	outdoor	A	20	25	16	16	16
Power supply lines	outdoor	# of wires	3x2,5	3x4,0	5x2,5	5x2,5	5x2,5
Control lines	ind. - outd.	x mm ²	4x1,5	4x1,5	4x1,5	4x1,5	4x1,5
Factory amount of refrigerant	up to 5 rm	kg	1,5	2,4	2,4	2,9	3,0
Additional amount of refrigerant	over 5 rm	g/m	24	24	24	24	24
External diameter of condensate drain		mm	25	25	25	25	25

Controllers

WIRELESS
REMOTE CONTROL



RG10N2

WIRED REMOTE
CONTROL



KJR-120X2
(OPTIONAL)

WIRED REMOTE
CONTROL



CCM
(OPTIONAL)



100



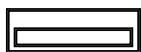

KTI 18 | 24 | 36 | 48 | 55 HWG32X

k^ti

Duct air conditioners are used in buildings with large areas. Their advantage lies in the ability to freely distribute air through the ducts and air intakes in the entire false ceiling space.

Slim series duct air conditioners are characterised by a high external static pressure – 160 Pa, while maintaining a low level of noise. The unit has a lower height than a standard duct unit, making it possible to install it in a small suspended ceiling space. The air conditioner automatically adjusts the static pressure and maintains a constant airflow.

101

A⁺ | R32





Features of **Kaisai kti**



Double sided installation



Refrigerant leakage indication



Cold air control



Emergency use



Self-diagnosis



Timer



Automatic restart



Alarm port



Remote control temperature sensor



Operation at low outside temperatures



Twin combination



Fresh air



On-off port



Temperature compensation



Built-in condensate pump



Compressor and condensate tray heaters

OPTIONAL



Central controller

OPTIONAL



Wi-Fi control

Technical specification

MODEL	jedn. wewn.		KTI-18HWG32X	KTI-24HWG32X	KTI-36HWG32X	KTI-36HWG32X	KTI-48HWG32X	KTI-55HWG32X
	jedn. zewn.		KOX330-18HF-N32X	KOX430-24HF-N32X	KOD30U-36HFJ32X	KOD30U-36HF-N32X	KOE30U-48HF-N32X	KOE30U-55HF-N32X
Capacity average (min÷max)	cooling	kW	5,3 (2,6÷5,9)	7,0 (3,3÷8,2)	10,6 (2,8÷11,1)	10,6 (2,7÷11,8)	14,1 (3,5÷15,5)	15,2 (4,1÷17,3)
	heating	kW	5,6 (2,2÷6,2)	7,6 (2,8÷8,5)	11,7 (2,8÷12,8)	11,7 (2,8÷12,8)	16,1 (4,1÷18,2)	18,2 (4,4÷20,5)
Energy class	cooling/heating		A+/A+	A++/A+	A++/A+	A++/A+	A++/A+	A++/A+
SEER	average	W/W	6,5	6,2	6,2	6,1	6,1	6,1
SCOP	average	W/W	4,0	4,0	4,0	4,0	4,0	4,0
Avg. power consumption (min÷max)	cooling	W	1530 (710÷2150)	2190 (750÷2960)	3950 (900÷4150)	4000 (890÷4200)	4800 (880÷6000)	5250 (1030÷6650)
	heating	W	1510 (740÷1760)	1900 (640÷2580)	3250 (800÷3950)	3250 (780÷4000)	4500 (950÷5700)	5150 (950÷6600)
Avg. operating current (min÷max)	cooling	A	7,1 (3,2÷9,6)	10,2 (4,2÷13,2)	17,5 (4,2÷18,5)	6,5 (1,4÷6,7)	8,4 (1,9÷10,4)	9,6 (3,1÷11,5)
	heating	A	6,8 (3,3÷7,7)	9,2 (3,8÷11,6)	14,5 (3,5÷17,5)	5,3 (1,3÷6,4)	8,0 (2,0÷9,8)	9,5 (2,0÷11,5)
Air flow rate	cooling	m³/h	911/706/515	1229/1035/825	2100/1800/1500	2100/1800/1500	2400/2040/1680	2600/2210/1820
	heating	m³/h	2200	3500	4000	4000	7500	7500
Available compression ratio		Pa	25/100	25/160	37/160	37/160	50/160	50/160
Operating temp. cooling/heating	indoor	°C	16÷32/0÷30	16÷32/0÷30	16÷32/0÷30	16÷32/0÷30	16÷32/0÷30	16÷32/0÷30
	outdoor	°C	-15+50/-15+24	-15+50/-15+24	-15+50/-15+24	-15+50/-15+24	-15+50/-15+24	-15+50/-15+24
Sound pressure level	indoor	dB(A)	41/38/34/26	42/40/37/27	49,5/48/46/42	49,5/48/46/42	50/49/47/42	52,5/49/47/42
	outdoor	dB(A)	56	60	63	63	63,5	64
Net dimensions w/h/d	indoor	mm	880/210/674	1100/249/774	1360/249/774	1360/249/774	1200/300/874	1200/300/874
	outdoor	mm	805/554/330	890/673/342	946/810/410	946/810/410	952/1333/415	952/1333/415
Transp. dimensions w/h/d	indoor	mm	1070/280/725	1305/315/805	1570/330/805	1570/330/805	1405/365/915	1405/365/915
	outdoor	mm	915/615/370	995/740/398	1090/885/500	1090/885/500	1095/1480/495	1095/1480/495
Net weight	indoor	kg	24,4	32,3	40,5	40,5	47,4	47,6
	outdoor	kg	26,6	43,9	66,9	80,5	103,7	107,0
Transport weight	indoor	kg	29,6	39,1	48,2	48,2	55,8	56,1
	outdoor	kg	29,0	46,9	71,5	85,0	118,3	121,2
Pipe diameter: liquid/gas		mm	6,35/12,7	9,52/15,9	9,52/15,9	9,52/15,9	9,52/15,9	9,52/15,9
Maximum installation length		m	30	50	75	75	75	75
Maximum height difference		m	20	25	30	30	30	30
Power supply	outdoor	V/Hz/Ph	220÷240/50/1	220÷240/50/1	220÷240/50/1	380÷420/50/3	380÷420/50/3	380÷420/50/3
Circuit breaker/fuse	outdoor	A	16	20	25	16	16	16
Power supply lines	outdoor	# of wires x mm²	3x2,5	3x2,5	3x4,0	5x2,5	5x2,5	5x2,5
Control lines	ind. - outd.		4x1,5	4x1,5	4x1,5	4x1,5	4x1,5	4x1,5
Factory amount of refrigerant	up to 5 rm	kg	1,15	1,5	2,4	2,4	2,9	3,0
Additional refrigerant	over 5 rm	g/m	12	24	24	24	24	24
Outer diameter of condensate drain		mm	25	25	25	25	25	25

Controllers

WIRED REMOTE CONTROL



KJR-120X2

WIRELESS REMOTE CONTROL



RG66A1 (OPTIONAL)

WIRED REMOTE CONTROL



KJR12B (OPTIONAL)

WIRED REMOTE CONTROL



CCM (OPTIONAL)

104





condensing units

Inverter condensing units are equipped with a control module, which enables connection of a universal outdoor unit to the freon exchanger in the air handling unit.

This solution makes it possible to control the capacity of the condensing unit by means of a 0-10 V signal sent from the automation of the air handling unit. Both cooling and heating operation is possible. The units have built-in expansion valves, so no additional refrigeration fittings are required. Kaisai condensing units can only be used with air-handling units equipped with safety features due to the flammable properties of the R32 refrigerant.

105





Technical specification

106

MODEL			KOX230-12HFN32X	KOX330-18HFN32X	KOX430-24HFN32X
Capacity average (min÷max)	cooling	kW	3,5(0,8÷4,1)	5,3(2,7÷5,9)	7,0(3,2÷7,8)
	heating	kW	3,8(0,5÷4,3)	5,6(2,4÷6,3)	7,6(2,7÷8,3)
Energy class	cooling/heating		A++/A+	A++/A+	A++/A+
SEER	średni	W/W	6,6	6,2	6,1
SCOP	średni	W/W	4,1	4,0	4,0
Average power consumption (min÷max)	cooling	W	1010(168÷1434)	1450(670÷2027)	2300(747÷2930)
	heating	W	1019(124÷1376)	1500(540÷1640)	2050(650÷2850)
Average operating current (min÷max)	cooling	A	4,4(1,3÷6,3)	6,0(3,2÷9,0)	10,5(3,9÷13,1)
	heating	A	4,7(1,0÷6,1)	6,6(2,7÷7,3)	9,5(3,5÷12,7)
Air flow rate		m ³ /h	2100	2200	3500
Operating temperature	cooling	°C	-15÷50/-15÷24	-15÷50/-15÷24	-15÷50/-15÷24
Sound pressure level		dB(A)	53,6	56	60
Net dimensions w/h/d		mm	765/555/303	805/554/330	890/673/342
Transport dimensions w/h/d		mm	887/610/337	915/615/370	995/740/398
Net weight		kg	26,6	26,6	43,9
Transport weight		kg	29,0	29,0	46,9
Pipe diameter: liquid/gas		mm	6,35/9,52	6,35/12,7	9,52/15,9
Maximum installation length		m	25	30	50
Maximum height difference		m	10	20	25
Power supply		V/Hz/Ph	220-240/50/1	220-240/50/1	220-240/50/1
Circuit breaker/fuse		A	16	16	20
Power supply lines		# of wires	3x2,5	3x2,5	3x2,5
Control lines		x mm ²	4x1,5	4x1,5	4x1,5
Factory amount of refrigerant	up to 5 rm	kg	0,72	1,15	1,5
Additional amount of refrigerant	over 5 rm	g/m	12	12	24

Technical specification

MODEL			KOD30U- -36HFJ32X	KOD30U- -36HFN32X	KOE30U- -48HFN32X	KOE30U- -55HFN32X
Capacity average (min÷max)	cooling	kW	10,6(2,7÷11,4)	10,6(2,7÷11,8)	14,1(3,5÷15,2)	15,8(4,1÷16,7)
	heating	kW	11,7(2,8÷12,8)	11,7(2,8÷12,8)	16,1(4,1÷17,0)	18,2(4,4÷19,6)
Energy class	cooling/heating		A++/A+	A++/A+	A++/A+	A++/A+
SEER	średni	W/W	6,2	6,4	6,1	6,1
SCOP	średni	W/W	4,0	4,1	4,0	4,0
Average power consumption (min÷max)	cooling	W	3900(900÷4250)	40000(890÷4300)	5000(900÷5950)	5650(1100÷6650)
	heating	W	3350(800÷3950)	3350(780÷3950)	5100(1000÷6050)	6050(1050÷7100)
Average operating current (min÷max)	cooling	A	17,0(4,2÷19,0)	6,3(1,4÷6,8)	8,8(1,9÷10,3)	9,7(3,2÷11,5)
	heating	A	15,0(3,5÷17,5)	5,4(1,3÷6,2)	8,9(2,1÷10,5)	10,5(2,2÷12,0)
Air flow rate		m³/h	4000	4000	7500	7500
Operating temperature	cooling	°C	-15+50/-15+24	-15+50/-15+24	-15+50/-15+24	-15+50/-15+24
Sound pressure level		dB(A)	63	63	63,5	64
Net dimensions w/h/d		mm	946/810/410	946/810/410	952/1333/415	952/1333/415
Transport dimensions w/h/d		mm	1090/885/500	1090/885/500	1095/1480/495	1095/1480/495
Net weight		kg	66,9	80,5	103,7	107,0
Transport weight		kg	71,5	85,0	118,3	121,2
Pipe diameter: liquid/gas		mm	9,52/15,9	9,52/15,9	9,52/15,9	9,52/15,9
Maximum installation length		m	75	75	75	75
Maximum height difference		m	30	30	30	30
Power supply		V/Hz/Ph	220-240/50/1	380-420/50/3	380-420/50/3	380-420/50/3
Circuit breaker/fuse		A	25	16	16	16
Power supply lines		# of wires x mm²	3x4,0	5x2,5	5x2,5	5x2,5
Control lines			4x1,5	4x1,5	4x1,5	4x1,5
Factory amount of refrigerant	up to 5 rm	kg	2,4	2,4	2,9	3,0
Additional amount of refrigerant	over 5 rm	g/m	24	24	24	24

107

Generator types and controllers



KOX230-12HFN32X
KOX330-18HFN32X
KOX430-24HFN32X
KOD30U-36HFJ32X
KOD30U-36HFN32X



KOE30U 48 | 55 HFN32X



Control Module
KMS-8140



kpph

kppd

Portable air conditioners

109

Portable air conditioners are perfect for places where you need to relocate or where stationary air conditioning is not possible.

KPPH air conditioners with a cooling capacity of 2.6 kW have cooling, dehumidification and condensate evaporation functions. It is the perfect solution for rooms with low heat loads, up to approx. 20 m². The KPPD model with a cooling capacity of 3.5 kW has an additional heating function and can also be used in larger rooms up to approx. 30 m².



KPPH-09HRG29

kpph

Portable air conditioners are ideal where relocation is needed or where stationary air conditioning is not an option.

The KPPH air conditioner has 3 basic operating modes: cooling, dehumidification and ventilation. The hot air is vented to the outside through a flexible ventilation duct.

110





Technical specification

MODEL		KPPH-09HRG29	
Capacity	cooling	kW	2,6
	heating	kW	-
Energy class	cooling/heating		A
EER	average	W/W	2,6
COP			-
Power consumption	cooling	W	1000
	heating	W	-
Operating current	cooling	A	4,4
	heating	A	-
Air flow rate		m ³ /h	295/195
Operating temperature		°C	17÷35
Sound pressure level		dB(A)	52/47,5
Net dimensions w/h/d		mm	355/703/345
Transport dimensions w/h/d		mm	400/870/370
Net weight		kg	24,7
Transport weight		kg	27,3
Electric power supply		V/Hz/Ph	220÷240/50/1
Refrigerant			R290
The amount of refrigerant		kg	0,17
Moisture removal rate		l/h	2,3

111

Controllers

WIRELESS
REMOTE CONTROL



RG51



KPPD-12HRG29

kpppd

Portable air conditioners are ideal where relocation is needed or where stationary air conditioning is not an option.

The KPPD air conditioner works in 4 basic operation modes: cooling, dehumidification, heating and ventilation. Control of the air conditioner is facilitated by the wireless remote control that comes as a standard.





Technical specification

MODEL		KPPD-12HRG29	
Capacity	cooling	kW	3,5
	heating	kW	2,9
Energy class	cooling/heating		A/A+
EER	average	W/W	2,6
COP			2,8
Power consumption	cooling	W	1350
	heating	W	1450
Operating current	cooling	A	5,9
	heating	A	5
Air flow rate		m ³ /h	420/370/355
Operating temperature		°C	17÷35/5÷30
Sound pressure level		dB(A)	52/51/50
Net dimensions w/h/d		mm	467/765/397
Transport dimensions w/h/d		mm	512/880/442
Net weight		kg	33,2
Transport weight		kg	37
Electric power supply		V/Hz/Ph	220÷240/50/1
Refrigerant			R290
The amount of refrigerant		kg	0,22
Moisture removal rate		l/h	3,4

113

Controllers

WIRELESS
REMOTE CONTROL



RG51

Everything is always under control

CONTROLLERS

WIRELESS
REMOTE CONTROL

RG10B, RG10B1

Controller dedicated for wall and floor mounted air conditioners

Basic functions: On/off | Operating mode | Air temperature | Fan speed | Timer | Remote control temperature sensor | Automatic blinds | Air direction | Turbo | Self-cleaning of evaporator | Sustained heating at 8°C | Eco

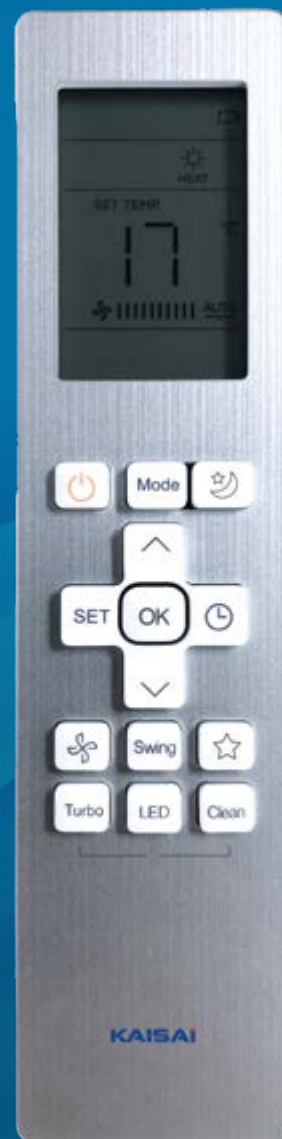

114



WIRED
CONTROLLER

KJR-120X2

Standard controller for duct air conditioners and optional controller for One + wall, cassette and floor/ceiling air conditioners.

Basic functions: On/off | Operating mode | Air temperature | Fan speed | Timer | Weekly programmer / Temperature sensor in remote control



WIRED
CONTROLLER

KJR12B

Optional controller for FLY wall-mounted and compact cassette air conditioners.

Basic functions: On/off | Operating mode | Air temperature | Fan speed | Timer | Temperature sensor in remote control | Auto blinds



WIRELESS
REMOTE CONTROL

RG66A1, RG66A2

Controller dedicated for wall, cassette, floor and ceiling mounted air conditioners and optional for duct units.

Basic functions: On/off | Operating mode | Air temperature | Fan speed | Timer | Remote control temperature sensor | Automatic blinds | Air direction | Turbo | Self-cleaning of evaporator | Sustained heating at 8°C



WIRELESS
REMOTE CONTROL

RG10N2

Controller dedicated for super slim cassette air conditioners.

Basic functions: On/Off | Operating mode | Air temperature | Fan speed | Timer | VANE function | Clock | ECO function | GEAR function | Breeze away function | Temperature sensor on remote control



WIRELESS
REMOTE CONTROL

RG10A, RG10A1

Controller dedicated for compact cassette, floor/ceiling and wall-mounted air conditioners from CARE and HOT series.

Basic functions: On/off | Operating mode | Air temperature | Fan speed | Timer | Remote control temperature sensor | Automatic blinds | Air direction | ECO | Ioniser | Sustained heating at 8°C



WIRELESS
REMOTE CONTROL

RG51

Controller dedicated for KPPD and KPPH portable air conditioners and optional for wall, cassette and floor/ceiling units.

Basic functions: On/off | Operating mode | Air temperature | Fan speed | Timer | Air direction | Auto blinds | Turbo



WIRED
CONTROLLER

KJR90A

Optional controller for FLY wall-mounted and compact cassette air conditioners.

Basic functions: On/off | Operating mode | Air temperature | Fan speed | Timer | Auto blinds | Clock



WIRED
CONTROLLER

CCM

Optional controller for cassette, floor/ceiling, wall-mounted One+ and duct air conditioners.

Control up to 64 indoor units. In addition to the standard functions, it has options for locking: operating mode, individual controls and central control buttons. The maximum length of communication cables is 1200 m.

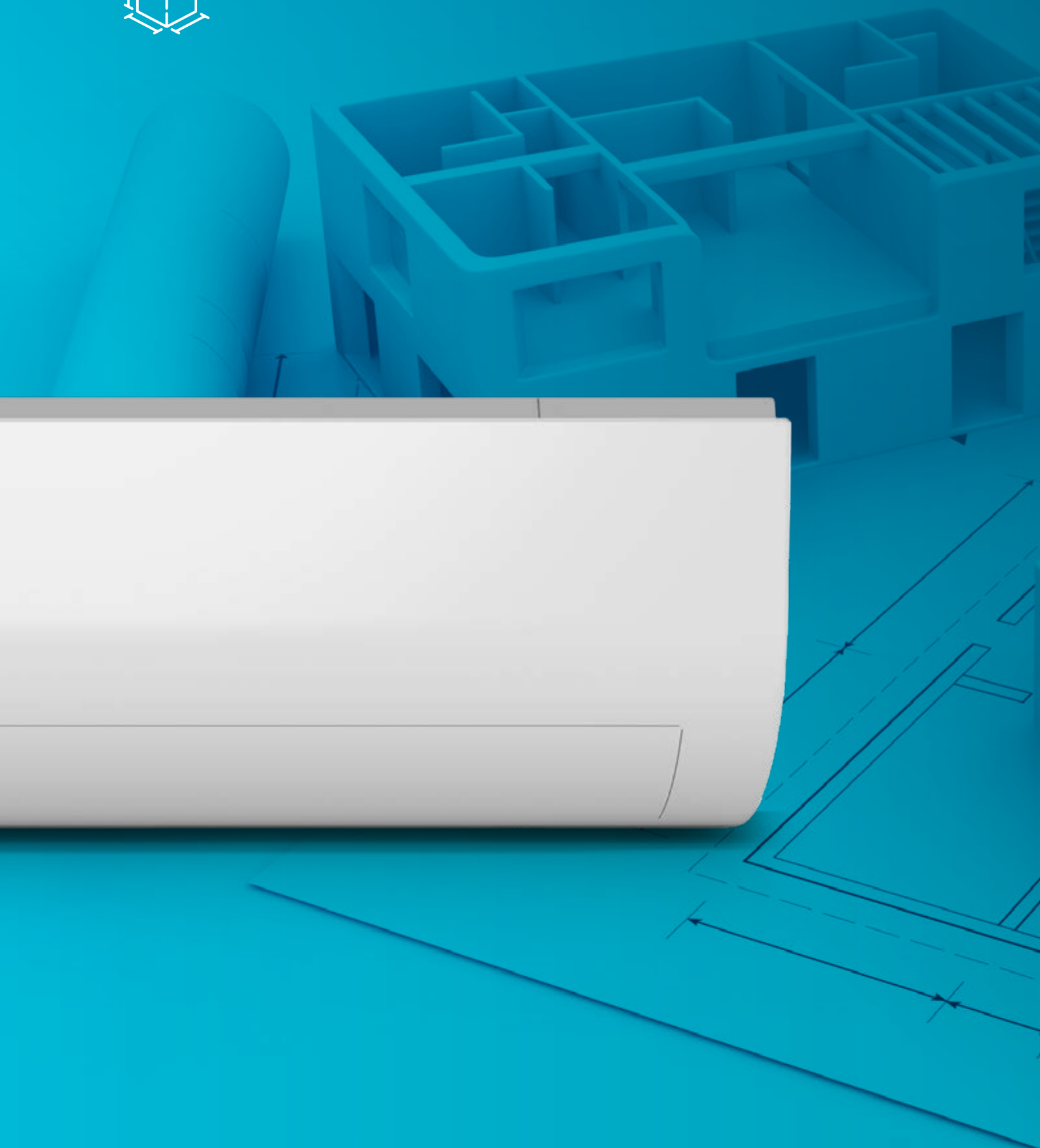

wall

floor and ceiling

floor

cassette

duct

multi

portable

Dimensions of the units

117

The compact size of Kaisai units provides a sleek look and convenience while maintaining high performance and ease of installation.

Kaisai air conditioners are energy efficient and easy to use units that require little space and provide the ideal room temperature in a very short time. All Kaisai air conditioners use environmentally friendly refrigerant and standard equipment includes Wi-Fi functionality for control using mobile devices. A number of practical functions ensuring optimal adjustment of the device to the needs of the user and a high level of comfort are available, depending on the model.

Dimensions

SPLIT UNITS

WALL FLY

MODEL	DIMENSIONS [mm]		
	W	D	H
KWX-09HRGI	805	194	285
KWX-12HRGI	805	194	285
KWX-18HRGI	957	213	302
KWX-24HRGI	1040	220	327

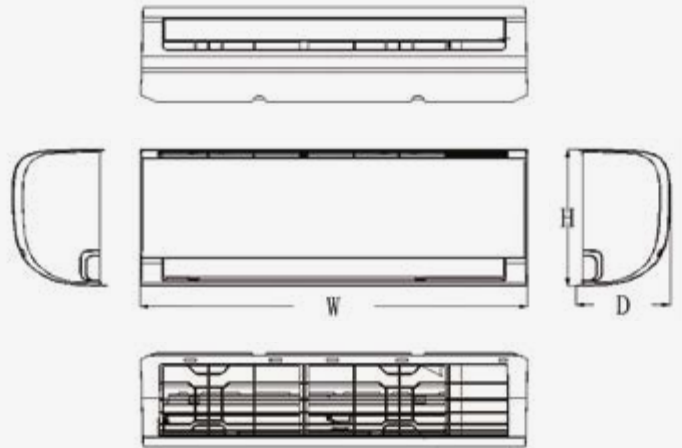

WALL ONE +

MODEL	DIMENSIONS [mm]		
	W	D	H
KRX-09PEGI	805	193	302
KRX-12PEGI	805	193	302
KRX-18PEGI	964	222	325
KRX-24PEGI	1106	232	342

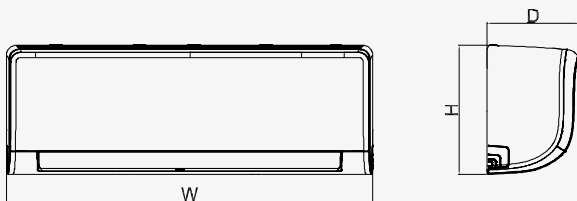
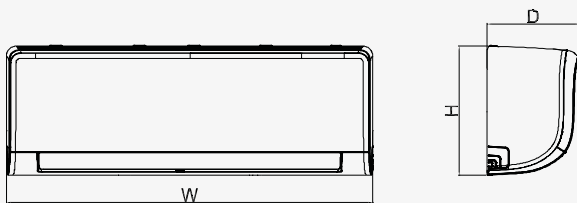
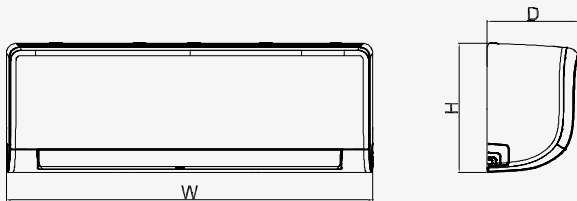

WALL CARE

MODEL	DIMENSIONS [mm]		
	W	D	H
KWC-12CGI	835	208	295
KWC-18CGI	969	241	320

WALL #290

MODEL	DIMENSIONS [mm]		
	W	D	H
KBA-12H29RI	805	193	302

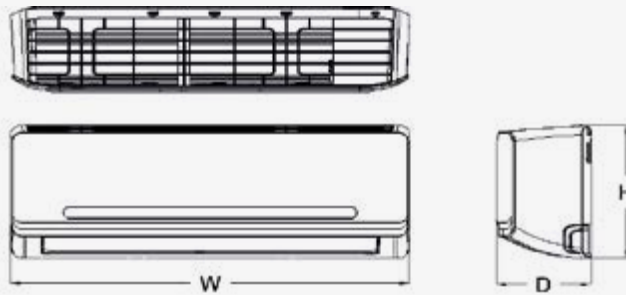

WALL GEO

MODEL	DIMENSIONS [mm]		
	W	D	H
KGE-12GRGI	802	189	297
KGE-18GRGI	965	215	319

WALL HOT

MODEL	DIMENSIONS [mm]		
	W	D	H
KSH-12HRHI	835	208	295

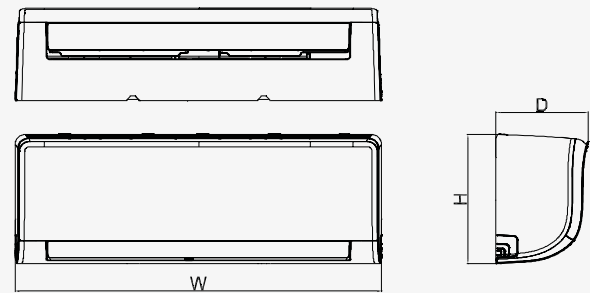

FLOOR AND CEILING

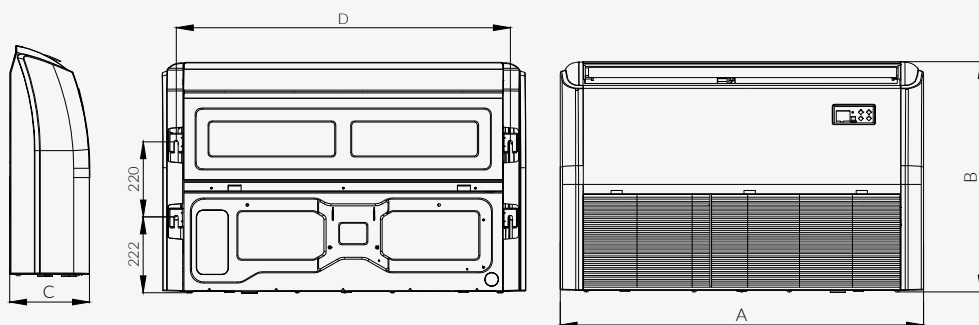

MODEL	DIMENSIONS [mm]				
	A	B	C	D	
KUE-18HRG32X	1068	675	235	983	
KUE-24HRG32X	1068	675	235	983	
KUE-36HRG32X	1650	675	235	1565	
KUE-48HRG32X	1650	675	235	1565	
KUE-55HRG32X	1650	675	235	1565	

PORTABLE **KPPH**

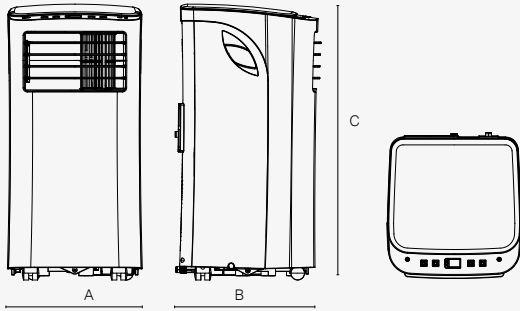

MODEL	DIMENSIONS [mm]		
	A	B	C
KPPH-09HRG29	355	345	703

PORTABLE **KPPD**

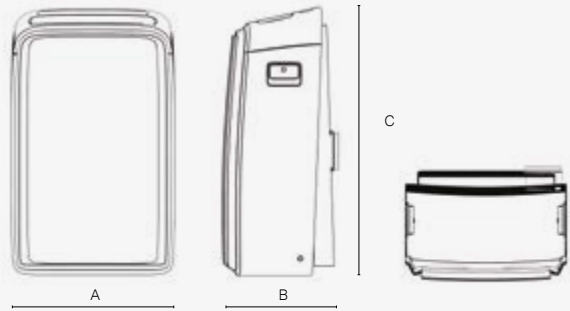

MODEL	DIMENSIONS [mm]		
	A	B	C
KPPD-12HRG29	467	397	765

120

DUCT **SLIM**

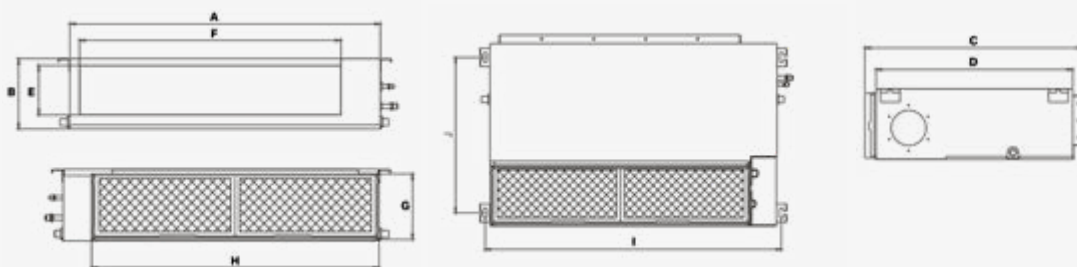

MODEL	DIMENSIONS [mm]									
	A	B	C	D	E	F	G	H	I	J
KTI-18HWG32X	880	210	674	600	136	706	190	782	920	508
KTI-24HWG32X	1100	249	774	700	175	926	228	1001	1140	598
KTI-36 HWG32X	1360	249	774	700	175	1186	228	1261	1400	598
KTI-48HWG32X, KTI-55HWG32X	1200	300	874	800	227	1044	280	1101	1240	697

FLOOR

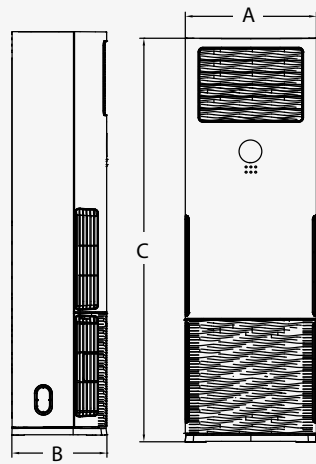

MODEL	DIMENSIONS [mm]		
	A	B	C
KFS-48HRG32X	629	456	1935

CASSETTE **KOMPAKT**

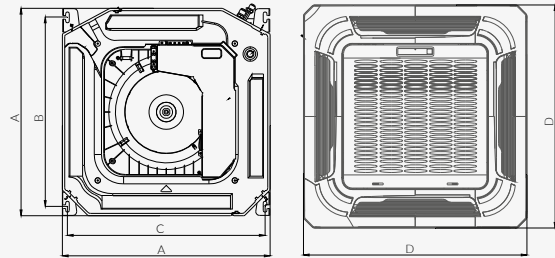

MODEL	DIMENSIONS [mm]					
	A	B	C	D	E	H
KCA3U-12HRG32X	570	523	545	647	50	260
KCA3U-18HRG32X	570	523	545	647	50	260

CASSETTE **SUPER SLIM**

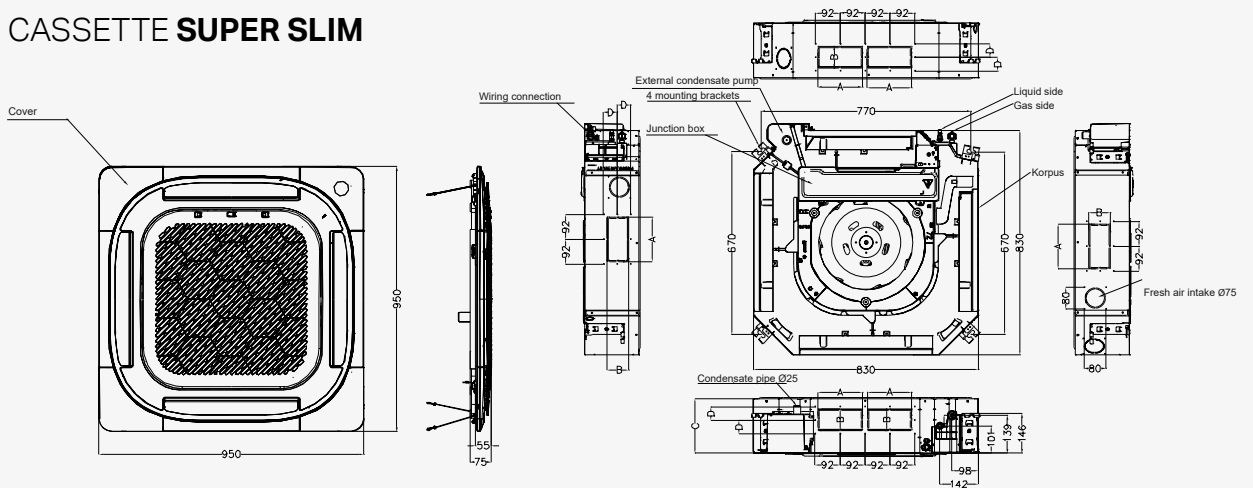

MODEL	DIMENSIONS [mm]			
	A	B	C	D
KCD-24HRG32X	165	80	204	50
KCD-36HRG32X	165	100	245	60
KCD-48HRG32X	165	100	287	60
KCD-55HRG32X	165	100	287	60

Dimensions

MULTI SPLIT APPLIANCES

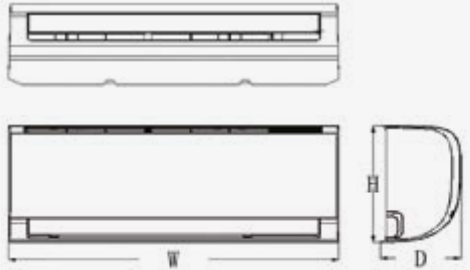

WALL FLY

MODEL	DIMENSIONS [mm]		
	W	D	H
KWX-09HRGI	805	194	285
KWX-12HRGI	805	194	285
KWX-18HRGI	957	213	302
KWX-24HRGI	1040	220	327

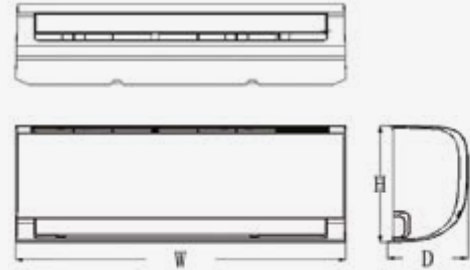

WALL ONE+

MODEL	DIMENSIONS [mm]		
	W	D	H
KRX-09PEGI	805	193	302
KRX-12PEGI	805	193	302
KRX-18PEGI	964	222	325
KRX-24PEGI	1106	232	342

122

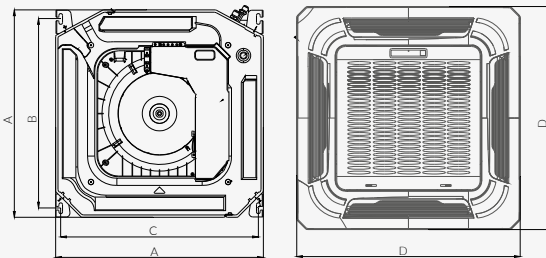

CASSETTE

MODEL	DIMENSIONS [mm]					
	A	B	C	D	E	F
KCA3I-09HRG32X	570	523	545	647	50	260
KCA3U-12HRG32X	570	523	545	647	50	260
KCA3U-18HRG32X	570	523	545	647	50	260

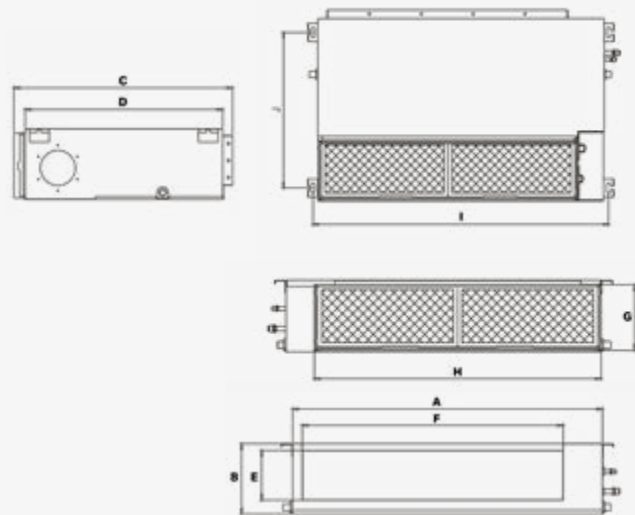

DUCT

MODEL	DIMENSIONS [mm]									
	A	B	C	D	E	F	G	H	I	J
KTI-18HWG32X	880	210	674	600	136	706	190	782	920	508

Dimensions

OUTDOOR UNITS

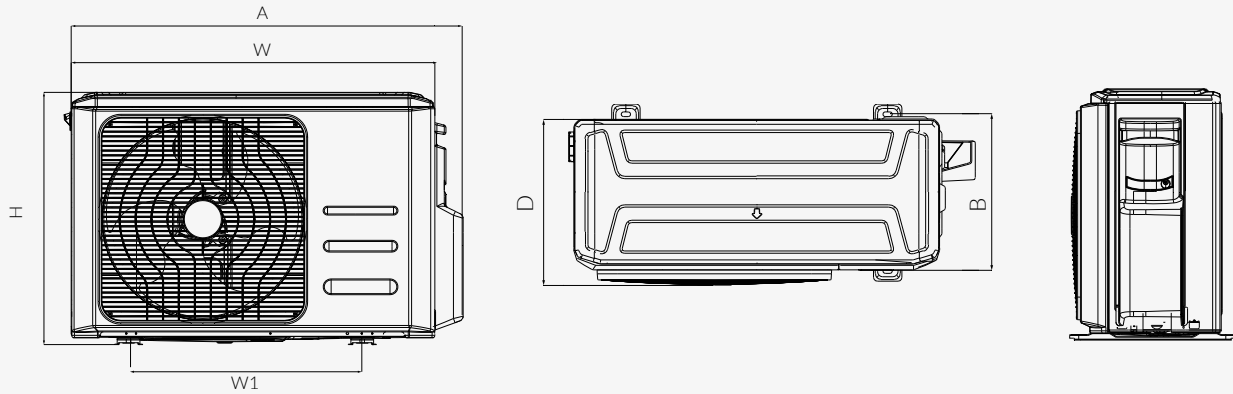

FOR WALL MODELS

MODEL	DIMENSIONS [mm]					
	W	D	H	W1	A	B
KWX-09HRGO	720	270	495	452	790	255
KWX-12HRGO	720	270	495	452	790	255
KWX-18HRGO	805	330	554	511	874	317
KWX-24HRGO	890	342	673	663	955	348
KRX-09PEGO	765	303	555	452	835	286
KRX-12PEGO	765	303	555	452	835	286
KRX-18PEGO	805	330	554	511	874	317
KRX-24PEGO	890	342	673	663	955	348
KGE-12GRGO	765	303	555	452	835	286
KGE-18GRGO	805	330	554	511	874	317
KWC-12CGO	720	270	495	452	790	255
KWC-18CGO	874	330	554	511	874	317
KSH-12HRGO	765	303	555	452	835	286
KBA-12H29RO	805	330	554	511	874	317

FOR CASSETTE, FLOOR, FLOOR/CEILING MOUNTED AND DUCT MODELS

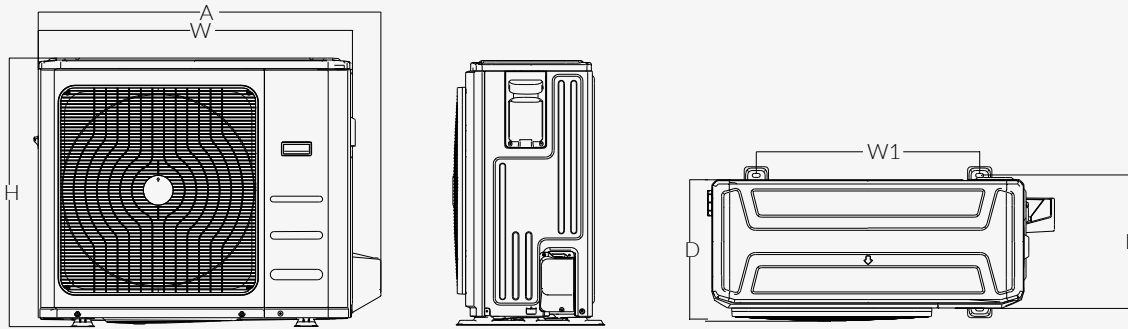

KOX230-12HFN32X, KOX330-18HFN32X, KOX430-24HFN32X, KOD30U-36HFJ32X, KOD30U-36HFN32X

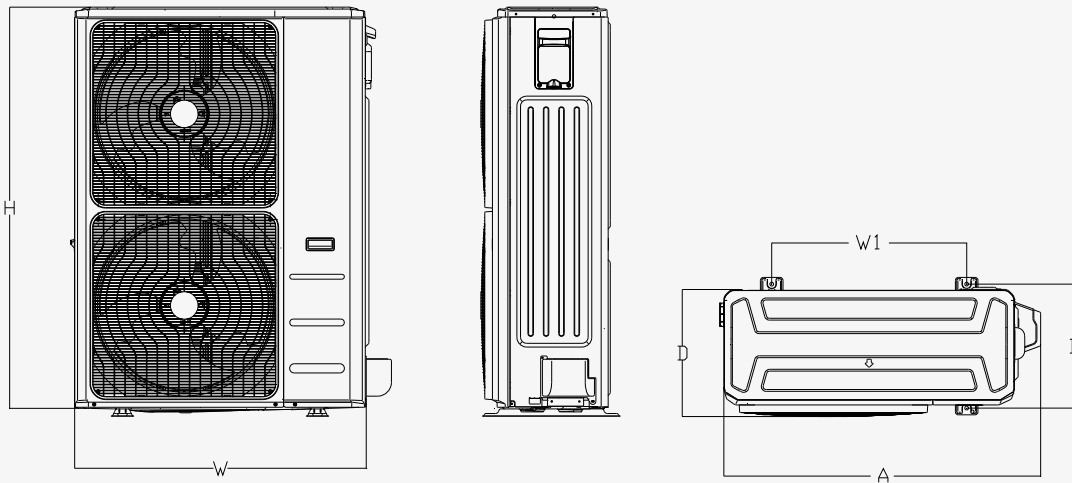

KOE30U-48HFN32X, KOE30U-55HFN32X

MODEL	DIMENSIONS [mm]					
	W	D	H	W1	A	B
KOX230-12HFN32X	765	303	555	452	835	286
KOX330-18HFN32X	805	330	554	511	874	317
KOX430-24HFN32X	890	342	673	663	955	348
KOD30U-36HFJ32X	946	410	810	673	1030	403
KOD30U-36HFN32X	946	410	810	673	1030	403
KOE30U-48HFN32X	952	415	1333	634	1045	404
KOE30U-55HFN32X	952	415	1333	634	1045	404

FOR MULTI MODELS

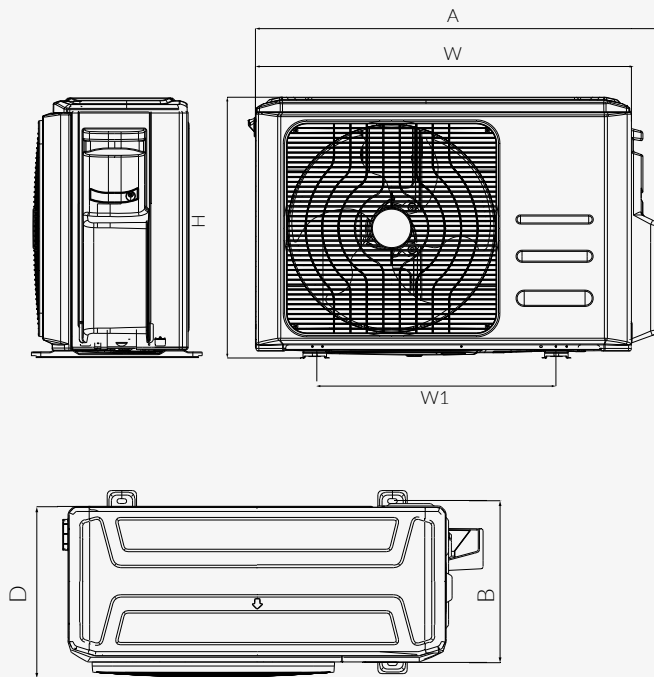

MODEL	DIMENSIONS [mm]					
	W	D	H	W1	A	B
K2OE-18HFN32H	805	330	554	511	877	317
K3OA-27HFN32H	890	342	673	663	990	354
K4OE-28HFN32H	946	410	810	673	1034	403
K4OB-36HFN32H	946	410	810	673	1034	403
K5OE-42HFN32H	946	410	810	673	1034	403

Accessories



SEQUENTIAL CONTROLLER

SPN-IR

Applies to all split air conditioner models

It is used to control the operation of 2 air conditioners (optionally 4) in an alternate manner. The controller communicates with air conditioners using an infra-red module (copies the signal from the wireless remote control).



SEQUENTIAL CONTROLLER

TS4

Applies to all split air conditioner models (except wall units)

It is used to control the operation of 2 to 4 devices in the alternate mode. The TS4 controller replaces time switches and other complex electrical systems and communicates with air conditioners via a wired installation.

126



WINTER KITS

FOR THE HEATING FUNCTION

Applies to all split models

The kit consists of compressor and drip tray heaters and a thermostat. It quickly removes snow and ice from the outdoor unit, ensuring trouble-free operation during winter.



FOR THE COOLING FUNCTION

Applies to all split models

The kit consists of a compressor heater and a thermostat. Prevents absorption of refrigerant by oil.



CONTROL MODULE
FOR AIR
HANDLING UNIT

KMS-8140

Applies to condensing units with communication lines L,N,S

The module allows the inverter condensing unit to be controlled by a 0-10 V DC signal from the air handling unit automation.



CONTROL MODULE
FOR AIR
HANDLING UNIT

KMS-8243

Applies to units with communication lines S1,S2

The module allows the inverter condensing unit to be controlled by a 0-10 V DC signal from the air handling unit automation.



CONNECTION SET FOR WIRED
REMOTE CONTROL

ZPPP-FLY

Applies to FLY air conditioners

The kit allows you to connect a KJ-R-12B or KJR-90A wired remote control to a Kaisai FLY series air conditioner.



EXTENSION MODULE

MFB ONE +

Applies to ONE + air conditioners

Enables connection of: KJ-R-120X2 wired controller, CCM central controller, Modbus gateway, ON/OFF control signal, alarm signal output



DIAGNOSTIC MODULE

DR SMART

Applies to all split air conditioner models

The diagnostic module makes it possible to read the operating parameters of split air conditioners and facilitates their diagnosis and repair.

Accessories



MODBUS GATE

MD-AC-MBS1

Applies to all split air conditioner models

The gateway makes it possible to connect the air conditioner to the BMS central control system.

128

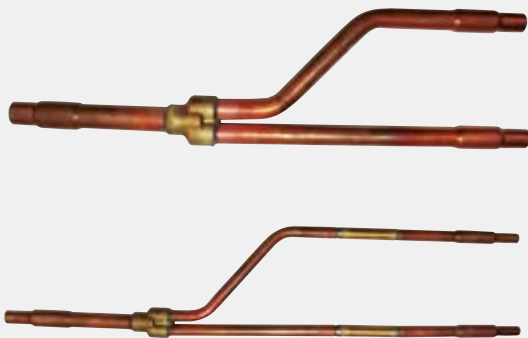

BRANCH PIPE

UTP-SX236 UTP-SX354A

For TWIN simultaneous system

T-pieces are required for the cooling installation of the Twin simultaneous system.



WIFI MODULE

OSK105

Applies to wall-mounted air conditioners

The module allows you to control your split air conditioner with your smartphone or tablet.



WIFI MODULE

LCAC

Applies to commercial air conditioners

The module allows you to control your split air conditioner with your smartphone or tablet.

Filters

SILVER ION FILTER

The silver ion filter is responsible for destroying bacteria and preventing the growth of micro-organisms such as viruses and fungi. The internal structure of the silver ions destroys micro-organisms.

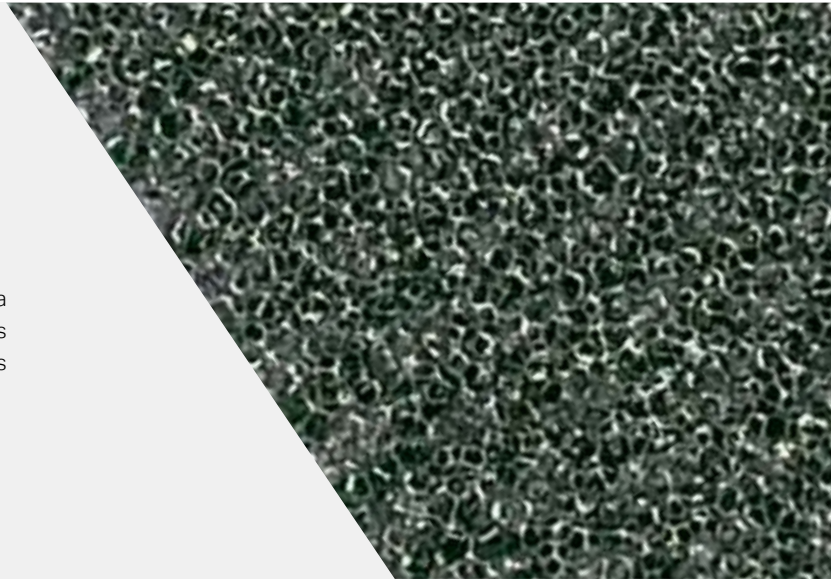

BIOHEPA FILTER

The air purification function is further supported by the Bio HEPA filter, which effectively traps 99% of dust particles and bacteria with a size of 0.3 µm and up to 95% of particles from 0.1 to 0.3 µm, including fungal cells and some viruses.



VITAMIN C FILTER

The filter emits vitamin C, which has a positive effect on the skin by protecting it from the sun's rays. Being an active antioxidant agent, vitamin C has a nourishing effect, stimulates collagen production and reduces stress.

129



3M FILTER

Thanks to its unique design, the filter captures dust particles and other harmful substances from the air, which can cause many respiratory diseases.

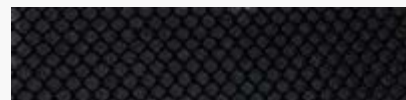

COLD CATALYTIC FILTER

The cold-catalytic filter eliminates chemicals such as carbon monoxide, hydrogen sulphide, ammonia, benzene and formaldehyde.

KAISAI

AIR CONDITIONING | HEATING
VENTILATION | PHOTOVOLTAICS

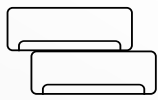

AIR
CONDITIONING

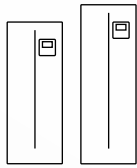

HEAT
PUMPS

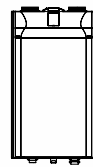

HEAT RECOVERY
UNITS

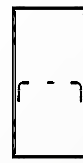

PHOTOVOLTAIC
MODULES AND INVERTERS



The full range of products is available on our website [kaisai.com](https://www.kaisai.com)

Contact details

FOR CONSUMERS:

Are you interested in buying our products?
Check the current list of Distributors in Poland at: www.kaisai.com

FOR DISTRIBUTORS AND INSTALLERS:

HEAD OFFICE

ul. Ostrobramska 101A
04-041 Warsaw
22 517 36 00 | 22 879 99 07

SALES DEPARTMENT

22 465 65 85
handlowy@kaisai.com

Do you want to become our Distributor? Write or call us.

KLIMA-THERM GROUP ACADEMY:

GDAŃSK BRANCH

ul. Budowlanych 48
80-298 Gdańsk
58 768 03 33

WARSAW BRANCH

ul. Ostobramska 101A
04-041 Warsaw
22 517 36 00

KATOWICE BRANCH

ul. Chorzowska 108, Budynek B
40-101 Katowice
32 209 49 26

Do you want to obtain an authorisation certificate and become our Installer?

Contact us: handlowy@kaisai.com

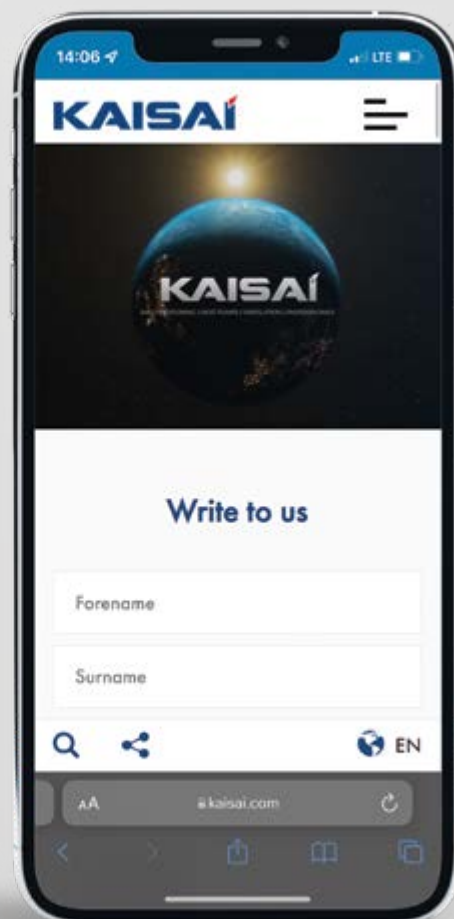

This document is for information and demonstration of Kaisai brand air conditioners. | Since the technologically advanced production process necessitates its continuous control and improvement, the information contained in this publication may be subject to change. | Specifications and prices shown in the catalogue are subject to change. Up-to-date information is always available on the website: www.kaisai.com



kaisai.com