

KAISAI



INSTALLATION MANUAL

CEILING & FLOOR TYPE

Thank you very much for purchasing our air conditioner,
Before using your air conditioner, please read this manual carefully and keep it for future reference.

KAISAI

- If used as MULTI unit, please refer to the Installation & operation manuals packed with outdoor unit.

CONTENTS

	Page
PRECAUTIONS.....	1
INSTALLATION INFORMATION.....	2
ACCESSORIES.....	3
INDOOR UNIT INSTALLATION.....	4
OUTDOOR UNIT INSTALLATION.....	6
INSTALL THE REFRIGERANT PIPE.....	8
CONNECT THE DRAIN PIPE.....	10
ELECTRIC WIRING WORK.....	11
TWINS FUNCTION.....	13
TEST OPERATION.....	13

PRECAUTIONS

-
- Keep this manual where the operator can easily find them.
 - Read this manual attentively before starting up the units.
 - For safety reason the operator must read the following cautions carefully.
-

The safety precautions listed here are divided into two categories.



WARNING

If you do not follow these instructions exactly, the unit may cause property damage, personal injury or loss of life.



CAUTION

If you do not follow these instructions exactly, the unit may cause minor or moderate property damage, personal injury.

After completing the installation, make sure that the unit operates properly during the start-up operation. Please instruct the customer on how to operate the unit and keep it maintained. Also, inform customers that they should store this installation manual along with the owner's manual for future reference.



WARNING

Be sure only trained and qualified service personnel to install, repair or service the equipment.

Improper installation, repair, and maintenance may result in electric shocks, short-circuit, leaks, fire or other damage to the equipment.

Install according to this installation instructions strictly. If installation is defective, it will cause water leakage, electrical shock and fire.

When installing the unit in a small room, take measures against to keep refrigerant concentration from exceeding allowable safety limits in the event of refrigerant leakage. Contact the place of purchase for more information. Excessive refrigerant in a closed ambient can lead to oxygen deficiency.

Use the attached accessories parts and specified parts for installation. otherwise, it will cause the set to fall, water leakage, electrical shock and fire.

Install at a strong and firm location which is able to withstand the set's weight. If the strength is not enough or installation is not properly done, the set will drop to cause injury.

The appliance shall not be installed in the laundry.

Before obtaining access to terminals, all supply circuits must be disconnected.

The appliance must be positioned so that the plug is accessible.

The enclosure of the appliance shall be marked by word, or by symbols, with the direction of the fluid flow.

For electrical work, follow the local national wiring standard, regulation and this installation instructions. An independent circuit and single outlet must be used. If electrical circuit capacity is not enough or defect in electrical work, it will cause electrical shock or fire.

Use the specified cable and connect tightly and clamp the cable so that no external force will be acted on the terminal. If connection or fixing is not perfect, it will cause heat-up or fire at the connection.

Wiring routing must be properly arranged so that control board cover is fixed properly. If control board cover is not fixed perfectly, it will cause heat-up at connection point of terminal, fire or electrical shock.

If the supply cord is damaged, it must be replaced by the manufacture or its service agent or a similarly qualified person in order to avoid a hazard.

An all-pole disconnection switch having a contact separation of at least 3mm in all poles should be connected in fixed wiring.

When carrying out piping connection, take care not to let air substances go into refrigeration cycle. Otherwise, it will cause lower capacity, abnormal high pressure in the refrigeration cycle, explosion and injury.

Do not modify the length of the power supply cord or use of extension cord, and do not share the single outlet with other electrical appliances. Otherwise, it will cause fire or electrical shock.

Carry out the specified installation work after taking into account strong winds, typhoons or earthquakes. Improper installation work may result in the equipment falling and causing accidents.

If the refrigerant leaks during installation, ventilate the area immediately.

Toxic gas may be produced if the refrigerant comes into the place contacting with fire.

The temperature of refrigerant circuit will be high, please keep the interconnection cable away from the copper tube.

After completing the installation work, check that the refrigerant does not leak.

Toxic gas may be produced if the refrigerant leaks into the room and comes into contact with a source of fire, such as a fan heater, stove or cooker.

- There are inflammable materials or gas.
- There is acid or alkaline liquid evaporating.
- Other special conditions.

The appliance shall be installed in accordance with national wiring regulations.

Do not operate your air conditioner in a wet room such as a bathroom or laundry room.

An all-pole disconnection device which has at least 3mm clearances in all poles, and have a leakage current that may exceed 10mA, the residual current device (RCD) having a rated residual operating current not exceeding 30mA, and disconnection must be incorporated in the fixed wiring in accordance with the wiring rules.



CAUTION

Ground the air conditioner.

Do not connect the ground wire to gas or water pipes, lightning rod or a telephone ground wire. Inappropriate grounding may result in electric shocks.

Be sure to install an earth leakage breaker.

Failure to install an earth leakage breaker may result in electric shocks.

Connect the outdoor unit wires, then connect the indoor unit wires.

You are not allowed to connect the air conditioner with the power supply until the wiring and piping is done.

While following the instructions in this installation manual, install drain piping in order to ensure proper drainage and insulate piping in order to prevent condensation.

Improper drain piping may result in water leakage and property damage.

Install the indoor and outdoor units, power supply wiring and connecting wires should be at least 1 meter away from televisions or radios in order to prevent image interference or noise.

Depending on the radio waves, a distance of 1 meter may not be sufficient enough to eliminate the noise.

The appliance is not intended for use by young children or infirm persons without supervision.

Don't install the air conditioner in the following circumstance:

- There is petrolatum existing.
- There is salty air surrounding (near the coast).
- There is caustic gas (the sulfide, for example) existing in the air (near a hot spring).
- The Volt vibrates violently (in the factories).
- In buses or cabinets.
- In kitchen where it is full of oil gas.
- There is strong electromagnetic wave existing.

INSTALLATION INFORMATION











- To install properly, please read this "installation manual" at first.
- The air conditioner must be installed by qualified persons.
- When installing the indoor unit or its tubing, please follow this manual as strictly as possible.
- If the air conditioner is installed on a metal part of the building, it must be electrically insulated according to the relevant standards to electrical appliances.
- When all the installation work is finished, please turn on the power only after a thorough check.
- Regret for no further announcement if there is any change of this manual caused by product improvement.

INSTALLATION ORDER

- Indoor unit installation;
- Outdoor unit installation;
- Install the refrigerant pipe;
- Connect the drain pipe ;
- Electric wiring work;
- Twins function;
- Test operation.

ATTACHED FITTINGS

Please check whether the following fittings are of full scope. If there are some spare fittings , please restore them carefully.

	NAME	SHAPE	QUANTITY
Remote controller & Its Frame (Match with remote controller)	6. Remote controller		1 (on some models)
	7. Frame		1 (on some models)
	8. Mounting screw(ST2.9*0-C-H)		2 (on some models)
	9. Alkaline dry batteries(Am4)		2 (on some models)
	10. Remote controller manual		1 (on some models)
Wire controller & Its Frame (Match with wire controller)	11. Wire controller		1 (on some models)
	12. Wire controller owner's manual		1 (on some models)
	13. Wire controller installation manual		1 (on some models)
Others	15. Owner's manual		1
	16. Installation manual		1

1.2 The dimension of the unit

1. INDOOR UNIT INSTALLATION

1.1 Installation place

The indoor unit should be installed in a location that meets the following requirements:

- There is enough room for installation and maintenance.
- The ceiling is horizontal, and its structure can endure the weight of the indoor unit.
- The outlet and the inlet are not impeded, and the influence of external air is the least.
- The air flow can reach throughout the room.
- The connecting pipe and drainpipe could be extracted out easily.
- There is no direct radiation from heaters.

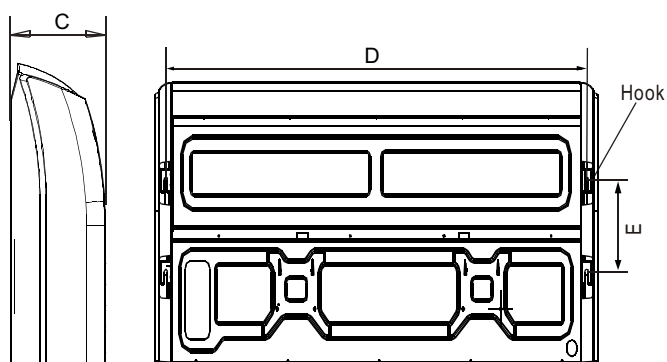
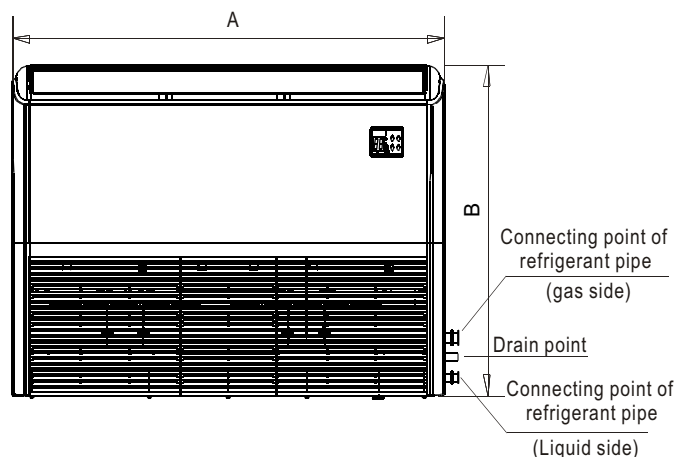
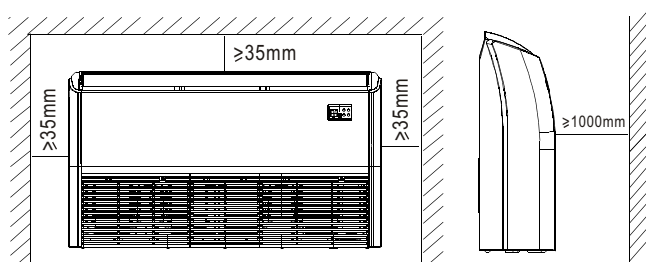

CAUTION

Keep indoor unit, outdoor unit, power supply wiring and transmission wiring at least 1 meter away from televisions and radios. This is to prevent image interference and noise in those electrical appliances. (Noise may be generated depending on the conditions under which the electric wave is generated, even if 1 meter is kept.)



NOTE

All the pictures in this manual are for explanation purpose only. There may be slightly different from the air conditioner you purchased (depend on model). The actual shape shall prevail.

Unit: mm

MODEL(Btu/h)	A	B	C	D	E
18K/24K	1068	675	235	983	220
30K	1285	675	235	1200	220
36K/42K/48K/55K	1650	675	235	1565	220

1.3 Install the main body

1 Installing $\varnothing 10$ hanging screw bolts. (4 bolts)

- Please refer to the following figures for positioning 4 screw bolts.
- Evaluate the ceiling construction and please install with $\varnothing 10$ hanging screw bolts.
- The handling to the ceiling varies from the constructions, consult the construction person for the specific condition.
 - Do keep the ceiling flat. Consolidate the roof beam to avoid possible vibration.
 - Cut off the roof beam.
 - Strengthen the place that has been cut off, and consolidate the roof beam.
- After the selection of installation location, position the refrigerant pipes, drain pipes, indoor & outdoor wires to the connection places before hanging up the machine.
- The installation of hanging screw bolts.



NOTE

Confirm the minimum drain tilt is 1/100 or more

1.3.1 Wooden construction

Put the square timber transversely over the roof beam, then install the hanging screw bolts.

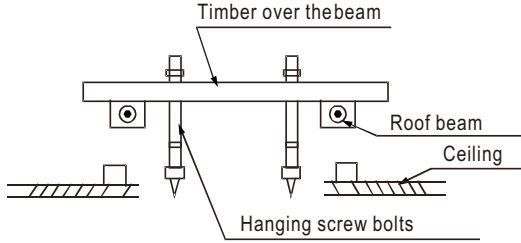

1.3.2 New concrete bricks

Inlaying or embedding the screw bolts.



(Blade shape insertion)



(Slide insertion)

Use embedding screw bolt, crock and stick harness.

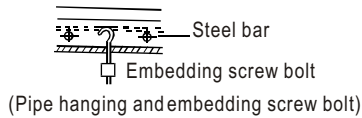

1.3.3 For Original concrete bricks

Install the hanging hook with expansible bolt into the concrete deep to 45~50mm to prevent loose.

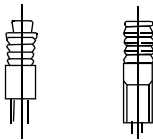

1.3.4 Steel roof beam structure

Install and use directly the supporting angle steel.

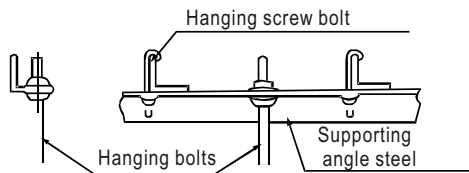

2 Overhanging the indoor unit

- Remove the side board and the grille.

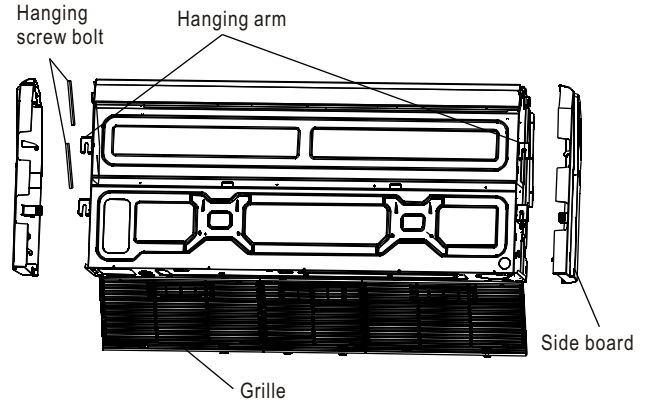

- Locate the hanging arm on the hanging screw bolt.

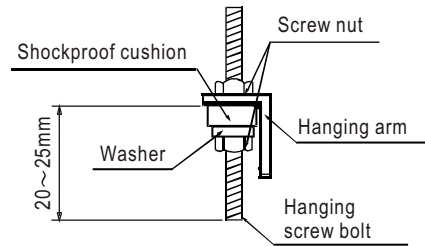

3. Ceiling Installation

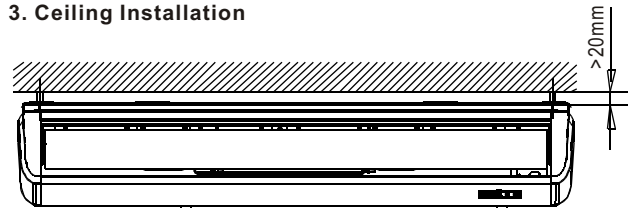

Connecting point of refrigerant pipe(gas side)

Connecting point of refrigerant pipe(Liquid side)

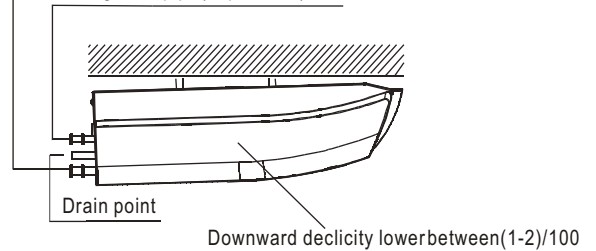

4. Wall Mounting Installation

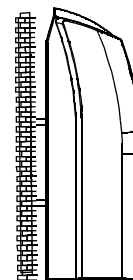

2.2 Figure of body size

2. OUTDOOR UNIT INSTALLATION

2.1 Precautions for selecting the location

- 1) Choose a place solid enough to bear the weight and vibration of the unit, where the operation noise will not be amplified.
- 2) Choose a location where the hot air discharged from the unit or the operation noise will not cause a nuisance to the neighbours of the user.
- 3) Avoid places near a bedroom and the like, so that the operation noise will cause no trouble.
- 4) There must be sufficient spaces for carrying the unit into and out of the site.
- 5) There must be sufficient space for air passage and no obstructions around the air inlet and the air outlet.
- 6) The site must be free from the possibility of flammable gas leakage in a nearby place.
- 7) Install units, power cords and inter-unit wire at least 3m away from television and radio sets. This is to prevent interference to images and sounds. (Noises may be heard even if they are more than 3m away depending on radio wave conditions.)
- 8) In coastal areas or other places with salty atmosphere of sulfate gas, corrosion may shorten the life of the air conditioner.
- 9) Since drain flows out of the outdoor unit, do not place under the unit anything which must be kept away from moisture.

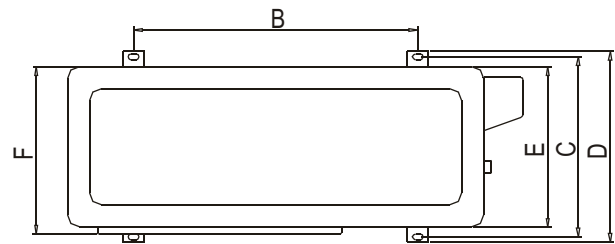
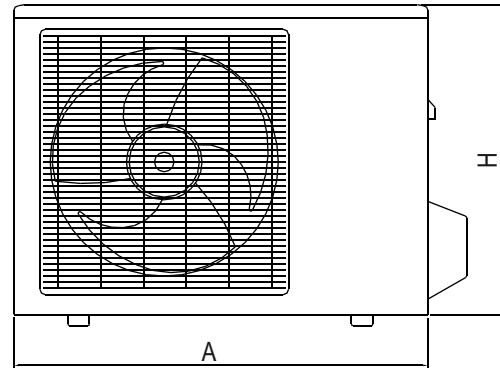

Unit:mm

MODEL(Btu/h)	A	B	C	D	E	F	H
12K/18K	810	549	325	350	305	310	558
24K	845	560	335	360	312	320	700
30K/36K/42K	945	640	405	448	385	395	810
48K/55K	938	634	404	448	368	392	1369

NOTE: Cannot be installed hanging from ceiling or stacked.



CAUTION

When operating the air conditioner in a low outdoor ambient temperature, be sure to follow the instructions described below.

- To prevent exposure to wind, install the outdoor unit with its suction side facing the wall.
- Never install the outdoor unit at a site where the suction side may be exposed directly to wind.
- To prevent exposure to wind, it is recommended to install a baffle plate on the air discharge side of the outdoor unit.
- In heavy snowfall areas, select an installation site where the snow will not affect the unit.

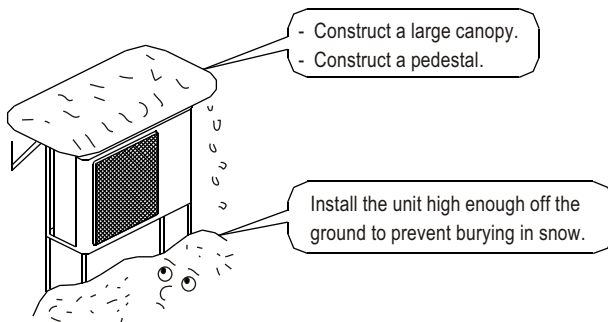

2.3 Installation guidelines

- Where a wall or other obstacle is in the path of outdoor unit's inlet or outlet airflow, follow the installation guidelines below.
- For any of the below installation patterns, the wall height on the outlet side should be 1200mm or less.

Wall facing one side

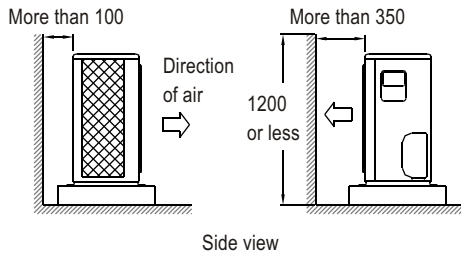

Side view

Walls facing two sides

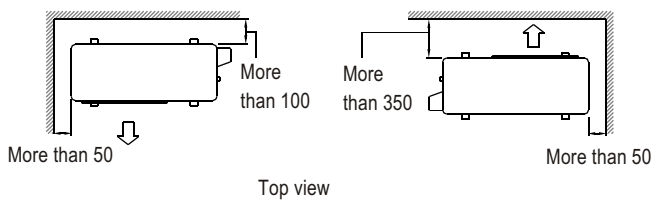

Top view

Walls facing three sides

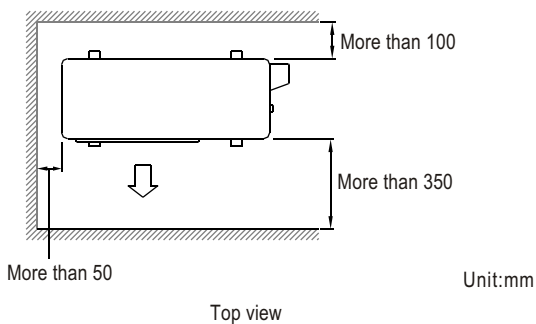

Top view

Unit:mm

2.4 Outdoor unit installation

1) Installing outdoor unit

- When installing the outdoor unit, refer to "Precautions for selecting the location".
- Check the strength and level of the installation ground so that the unit will not cause any operating vibration or noise after installed.
- Fix the unit securely by means of the foundation bolts. (Prepare 4 sets of M8 or M10 foundation bolts, nuts and washers each which are available on the market.)

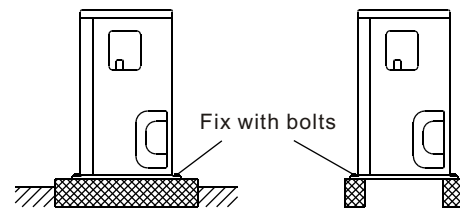

2) Drain work

- If drain work is necessary, follow the procedures below.
- Use drain plug for drainage.
- If the drain port is covered by a mounting base or floor surface, place additional foot bases of at least 30mm in height under the outdoor unit's feet.
- In cold areas, do not use a drain hose with the outdoor unit. (Otherwise, drain water may freeze, impairing heating performance.)

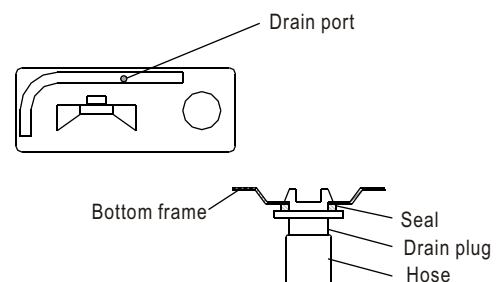

3 INSTALL THE REFRIGERANT PIPE

⚠ All field piping must be provided by a licensed refrigeration technician and must comply with the relevant local and national codes.

Precautions

- Execute heat insulation work completely on both sides of the gas piping and liquid piping. Otherwise, this can sometimes result in water leakage.
(When using a heat pump, the temperature of the gas piping can reach up to approximately 120°C. Use insulation which is sufficiently resistant.)
- Also, in cases where the temperature and humidity of the refrigerant piping sections might exceed 30°C or Rh80%, reinforce the refrigerant insulation(20mm or thicker). Condensation may form on the surface of the insulating material.
- Before rigging tubes, check which type of refrigerant is used.
- Use a pipe cutter and flare suitable for used refrigerant.
- Only use annealed material for flare connections.
- Do not mix anything other than the specified refrigerant, such as air, etc., Inside the refrigerant circuit.
- If the refrigerant gas leaks during the work, ventilate the area. A toxic gas is emitted by the refrigerant gas being exposed to a fire.
- Make sure there is no refrigerant gas leak. A toxic gas may be released by the refrigerant gas leaking indoor and being exposed to flames from an area heater, cooking stove, etc.
- Refer to the table below for the dimensions of flare nuts spaces and the appropriate tightening torque. (Overtightening may damage the flare and cause leaks.)

Pipe gauge (mm)	Tightening torque	Flare dimension A (mm)	Flare shape
Ø6.35	15~16 N. m (153~163 kgf.cm)	8.3~8.7	
Ø9.52	25~26 N. m (255~265 kgf.cm)	12.0~12.4	
Ø12.7	35~36 N. m (357~367 kgf.cm)	15.4~15.8	
Ø15.9	45~47 N. m (459~480 kgf.cm)	18.6~19.0	

- Check whether the height drop between the indoor unit and outdoor unit, and the length of refrigerant pipe meet the following requirements:

The type of models	Capacity (Btu/h)	Max.allowable piping length	Max.allowable piping height
R410A inverter Split type air conditioner	<15000	25m	10m
	≥15000~<24000	30m	20m
	≥24000~<36000	50m	25m
	≥36000~≤60000	65m	30m

3.1 Flaring the pipe end

- Cut the pipe end with a pipe cutter.
- Remove burrs with the cut surface facing downward so that the chips do not enter the pipe.

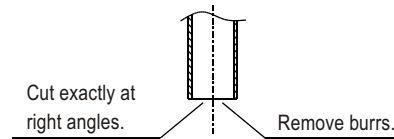

- Put the flare nut on the pipe.
- Flare the pipe.

Outer diam. (mm)	A(mm)	
	Max.	Min.
Ø6.35	1.3	0.7
Ø9.52	1.6	1.0
Ø12.7	1.8	1.0
Ø15.9	2.2	2.0

Set exactly at the position shown below.

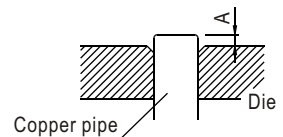

- Check that the flaring is properly made.

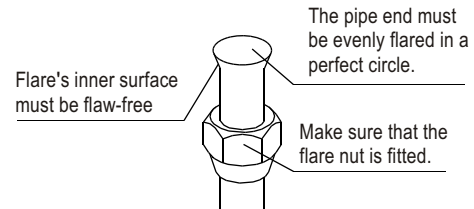

3.2 Refrigerant piping

- Coat the flare both inside and outside with ether oil or ester oil.

Coat here with ether oil or ester oil

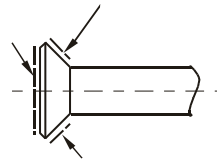

- Align the centres of both flares and tighten the flare nuts 3 or 4 turns by hand. Then tighten them fully with the torque wrenches.

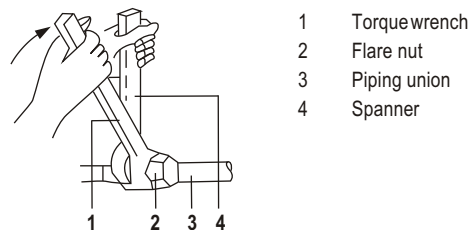

3.3 Purging air and checking gas leakage

- When piping work is completed, it is necessary to purge the air and check for gas leakage.



WARNING

- Do not mix any substance other than the specified refrigerant into the refrigeration cycle.
 - When refrigerant gas leaks occur, ventilate the room as soon as possible.
 - The specified refrigerant should always be recovered and never be released directly into the environment.
 - Use a vacuum pump for the specified refrigerant. Using the same vacuum pump for different refrigerants may damage the vacuum pump or the unit.
-
- If using additional refrigerant, perform air purging from the refrigerant pipes and indoor unit using a vacuum pump, then charge additional refrigerant.
 - Use a hexagonal wrench(4mm) to operate the stop valve rod.
 - All refrigerant pipe joints should be tightened with a torque wrench at the specified tightening torque.

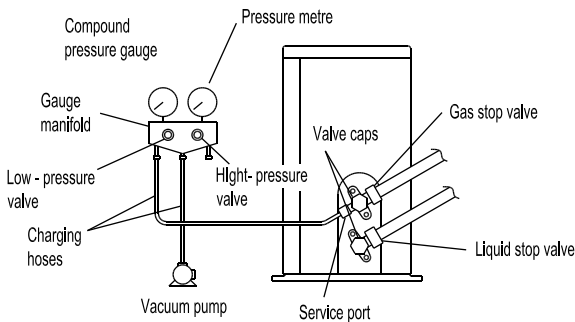

- Connect projection side of charging hose (which comes from gauge manifold) to gas stop valve's service port.
- Full open gauge manifold's low-pressure valve (Lo) and completely close its high-pressure valve (Hi) (High-pressure valve subsequently requires no operation.)
- Do vacuum pumping and make sure that the compound pressure gauge reads -0.1MPa (-76cmHg).^{*1}
- Close gauge manifold's low-pressure valve (Lo) and stop vacuum pump. (Keep this state for a few minutes to make sure that the compound pressure gauge pointer does not swing back.)^{*2}
- Remove caps from liquid stop valve and gas stop valve.
- Turn the liquid stop valve's rod 90 degrees counterclockwise with a hexagonal wrench to open valve. Close it after 5 seconds, and check for gas leakage. Using soapy water, check for gas leakage from indoor unit's flare and outdoor unit's flare and valve rods. After the check is complete, wipe all soapy water off.
- Disconnect charging hose from gas stop valve's service port then fully open liquid and gas stop valves. (Do not attempt to turn valve rod beyond its stop.)
- Tighten valve caps and service port caps for the liquid and gas stop valves with a torque wrench at the specified torques.

*1. Pipe length vs. Vacuum pump run time

Pipe length	Up to 15m	More than 15m
Run time	Not less than 10 min	Not less than 15min

- *2. If the compound pressure gauge pointer swings back, refrigerant may have water content or a loose pipe joint may exist. Check all pipe joints and retighten nuts as needed, then repeat steps 2) through 4).

3.4 Additional refrigerant charge



CAUTION

- Refrigerant may only be charged after performing the leak test and the vacuum pumping.
 - Check the type of refrigerant to be used on the machine nameplate. Charging with an unsuitable refrigerant may cause explosions and accidents, so always ensure that the appropriate refrigerant is charged.
 - Refrigerant containers shall be opened slowly.
-
- The outdoor unit is factory charged with refrigerant. Calculate the added refrigerant according to the diameter and the length of the liquid pipe of the outdoor unit/indoor unit connection.

Pipe length and refrigerant amount:

Connective pipe length	Air purging method	Additional amount of refrigerant to be charged	
Less than 5m	Use vacuum pump.	_____	
More than 5m	Use vacuum pump.	Liquid side: $\phi 6.35\text{mm}$ R410A: (L-5)x15g/m	Liquid side: $\phi 9.52\text{mm}$ R410A: (L-5)x30g/m

- Be sure to add the proper amount of additional refrigerant. Failure to do so may result in reduced performance.

3.5 Refrigerant pipig work

1) Caution on the pipe handling

- Protect the open end of the pipe against dust and moisture.
- All pipe bends should be as gentle as possible. Use a pipe bender for bending.

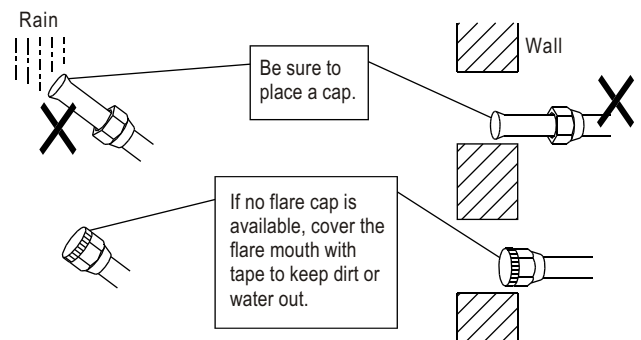

2) Be sure to insulate both the gas and liquid piping. Use separate thermal insulation pipes for gas and liquid refrigerant pipes. See the figure below.

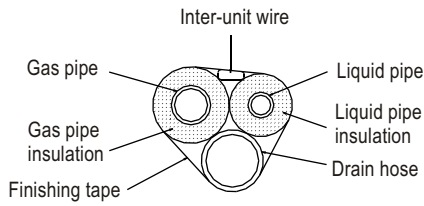

Piping insulation procedure

Gas piping

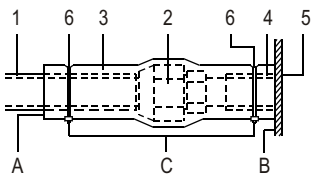

Liquid piping

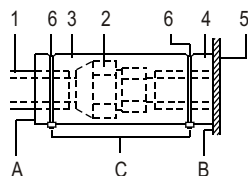

- 1 Piping insulation material(field supply)
- 2 Flare nut connection
- 3 Insulation for fitting (field supply)
- 4 Piping insulation material (main unit)
- 5 Indoor unit
- 6 Clamp (field supply)
- A Turn seams up
- B Attach to base
- C Tighten the part other than the piping insulation material



- For local insulation, be sure to insulate local piping all the way into the pipe connections inside the unit. Exposed piping may cause condensation or may cause burns when touched.
- Make sure that no oil remains on plastic parts of the decoration panel (optional equipment). Oil may cause degradation and damage to plastic parts.

4 CONNECT THE DRAIN PIPE

Install the drain pipes.

- Keep piping as short as possible and slope it downwards at a gradient of at least 1/100 so that air may not remain trapped inside the pipe.
- Keep pipe size equal to or greater than that of the connecting pipe (PVC pipe, nominal diameter 20mm in, outside diameter 25mm).
- Push the drain hose as far as possible over the drain socket, and tighten the metal clamp securely.

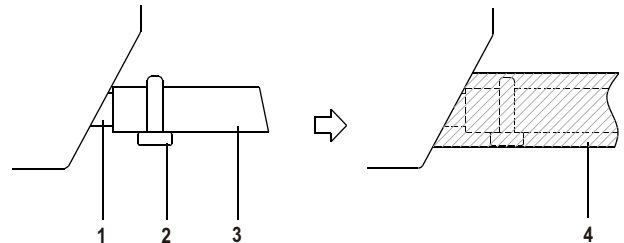

- 1 Drain socket (attached to the unit)
- 2 metal clamp
- 3 Drain hose
- 4 Insulation (field supply)

- Insulate the drain hose inside the building.
- If the drain hose cannot be sufficiently set on a slope, fit the hose with drain raising piping (field supply).
- Make sure that heat insulation work is executed on the following 2 spots to prevent any possible water leakage due to dew condensation.
 - 1 Indoor drain pipe.
 - 2 Drain socket.

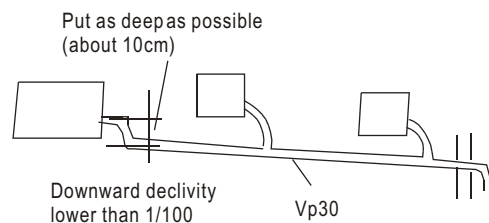
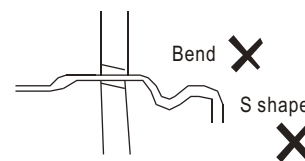
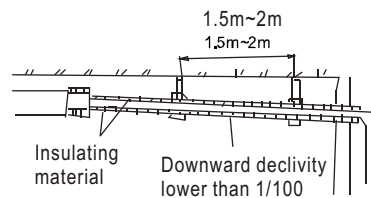

Drainage test

- Check whether the drainpipe is unhindered.
- New built house should have this test done before paving the ceiling.

5 ELECTRIC WIRING WORK

General instructions

- All field wiring and components must be installed by a licensed electrician and must comply with relevant European and national regulations.
- Use copper wire only.
- Follow the 'Wiring diagram' attached to the unit body to wire the outdoor unit, indoor units and the remote controller.
- A circuit breaker capable of shutting down power supply to the entire system must be installed.
- Note that the operation will restart automatically if the main power supply is turned off and then turned back on again.
- Be sure to ground the air conditioner.
- Do not connect the ground wire to gas pipes, water pipes, lightning rods, or telephone ground wires.
 - Gas pipes: might cause explosions or fire if gas leaks.
 - Water pipes: no grounding effect if hard vinyl piping is used.
 - Telephone ground wires or lightning rods: might cause abnormally high electric potential in the ground during lightning storms .

Minimum nominal cross-sectional area of conductors:

Rated current of appliance (A)	Nominal cross-sectional area (mm ²)
≤6	0.75
>6 and ≤10	1.0
>10 and ≤16	1.5
>16 and ≤25	2.5
>25 and ≤32	4.0
>32 and ≤45	6.0
>45 and ≤60	10.0

NOTE:

The cable size and the current of the fuse or switch are determined by the maximum current indicated on the nameplate which is located on the side panel of the unit. Please refer to the nameplate before selecting the cable, fuse and switch.

The specification of power

MODEL(Btu/h)		18K	24K	30K~36K	42K~48K	55K	30K~36K	42K~55K
POWER (indoor)	PHASE	1Phase	1Phase	1Phase	1Phase	1Phase	1Phase	1Phase
	FREQUENCY AND VOLT	220-240V	220-240V	220-240V	220-240V	220-240V	220-240V	220-240V
CIRCUIT BREAKER/FUSE(A)		15/10	15/10	15/10	15/10	15/10	15/10	15/10
POWER (outdoor)	PHASE	1Phase	1Phase	1Phase	1Phase	1Phase	3Phase	3Phase
	FREQUENCY AND VOLT	208-240V	208-240V	208-240V	208-240V	208-240V	380-415V	380-415V
	CIRCUIT BREAKER/FUSE(A)	30/20	30/20	40/30	40/35	50/40	30/20	30/20

How to connect wiring

- Remove the control box lid of the indoor unit.
Remove the cover of the outdoor unit.
- Follow the "Wiring diagram label" attached to the indoor unit's control box lid to wire the outdoor unit, indoor unit and the remote controller.
Securely fix the wires with a field supplied clamp.
- Attach the cover of the outdoor unit.

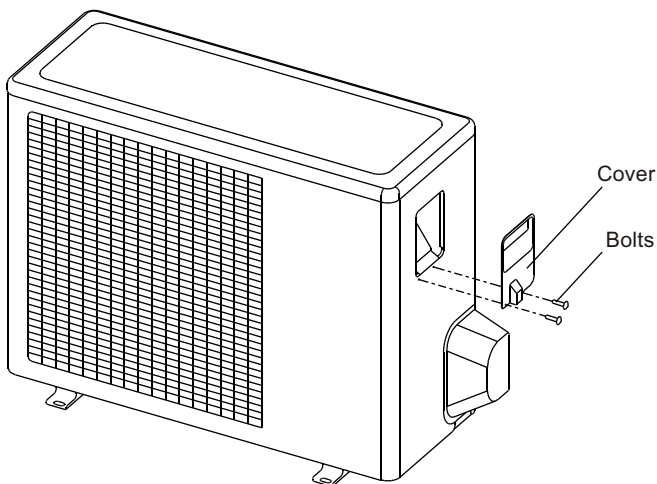
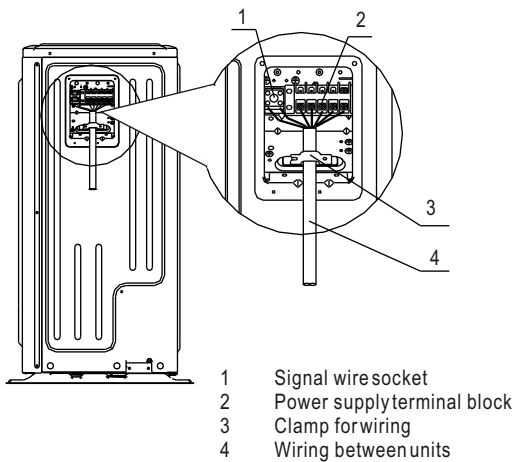
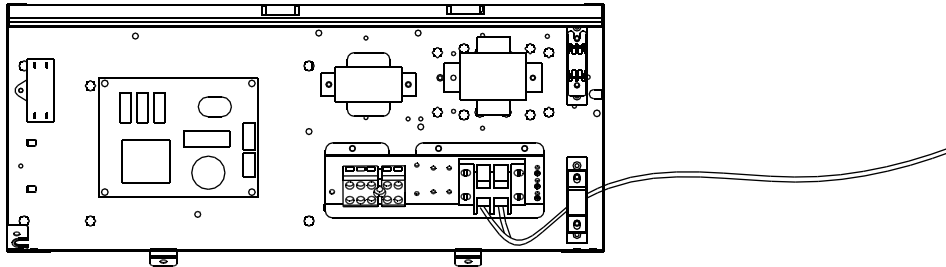

Precautions

- 1 Observe the notes mentioned below when wiring to the power supply terminal board.

- Do not connect wires of different gauge to the same power supply terminal. (Looseness in the connection may cause overheating.)
- When connecting wires of the same gauge, connect them according to the figure.

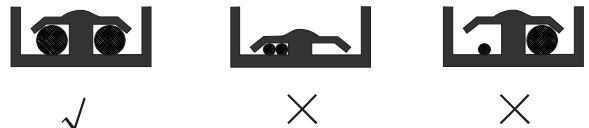

Use the specified electric wire. Connect the wire securely to the terminal. Lock the wire down without applying excessive force to the terminal. (Tightening torque: $1.31\text{N}\cdot\text{m} \pm 10\%$).

- When attaching the control box lid, make sure not to pinch any wires.
 - After all wiring connections are done, fill in any gaps in the casing wiring holes with putty or insulation material (field supply) thus to prevent small animals or dirt from entering the unit from outside and causing short circuits in the control box.
- 2 Do not connect wires of different gauge to the same grounding terminal. Looseness in the connection may deteriorate the protection.
 - 3 Use only specified wires and tightly connect wires to the terminals. Be careful that wires do not place external stress on the terminals. Keep wiring in neat order so that they do not obstruct other equipment such as popping open the service cover. Make sure the cover closes tight. Incomplete connections could result in overheating, and in the worst case, electric shock or fire.

6 REFRIGERANT PIPE(the unit with the twins function)

6.1 Length and drop height permitted of the refrigerant piping

Note: Reduced length of the branching tube is the 0.5m of the equivalent length of the pipe.

		Max value		Piping
Pipe length	Total pipe length (Actual)	18K+18K	30m	L+L1+L2
		24K+24K/ 30K+30K	50m	
	(farthest from the line pipe branch)	15m	L1;L2	
	(farthest from the line pipe branch)	10m	L1-L2	
Drop height	Indoor unit-outdoor unit drop height	20m	H1	
	Indoor unit to indoor unit drop height	0.5m	H2	

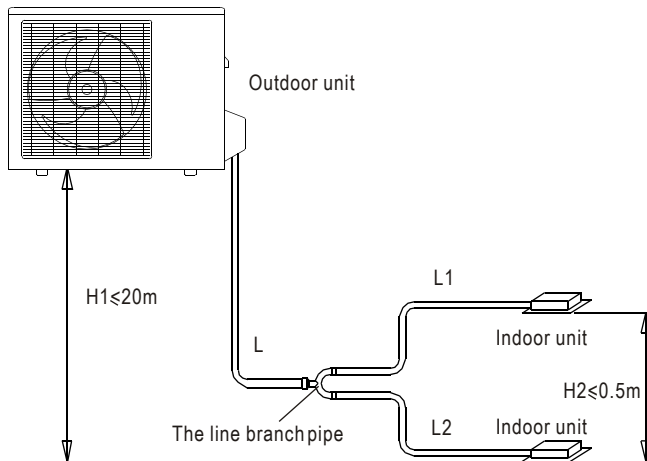

Note : All used branch pipe must be produced by Kaisai, otherwise it causes malfunction. The indoor units should be installed equivalently at the both side of the U type branch pipe.

The branching pipe must be installed horizontally, error angle of it should not large than 10° . Otherwise, malfunction will be caused.

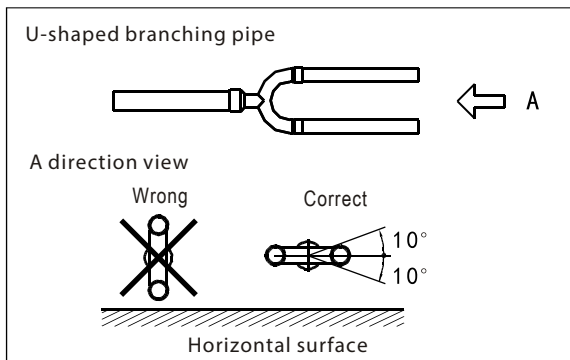

6.2 Refrigerant amount to be added

Calculate the added refrigerant according to the diameter and the length of the liquid side pipe of the outdoor/indoor unit connection. The refrigerant is R410A.

Pipe size on liquid side	Refrigerant to be added per meter
$\varnothing 6.35$	0.015kg
$\varnothing 9.5$	0.030kg

7 TEST OPERATION

Make sure the control box lids are closed on the indoor and outdoor units.

Refer to "For the following items, take special care during construction and check after installation is finished" on page 2.

After finishing the construction of refrigerant piping, drain piping, and electric wiring, conduct test operation accordingly to protect the unit.

Test operation after installing decoration panel

- 1 Open the gas side stop valve.
- 2 Open the liquid side stop valve.
- 3 Electrify crank case heater for 6 hours.
- 4 Set to cooling operation with the remote controller and start operation by pushing ON/OFF button.
- 5 Check the following points. If there is any malfunction, please resolve it according to the chapter "Troubleshooting" in the "Owner's Manual".

■ The indoor unit

- Whether the switch on the remote controller works well.
- Whether the buttons on the remote controller works well.
- Whether the air flow louver moves normally.
- Whether the room temperature is adjusted well.
- Whether the indicator lights normally.
- Whether the temporary buttons works well.
- Whether there is vibration or abnormal noise during operation.
- Whether the drainage flows smoothly.

■ The outdoor unit

- Whether there is vibration or abnormal noise during operation.
- Whether the generated wind, noise, or condensed of by the air conditioner have influenced your neighborhood.
- Whether any of the refrigerant is leaked.

- 6 Turn off the main power supply after operation.



A protection feature prevents the air conditioner from being activated for approximately 3 minutes when it is restarted immediately after shut off.



KAISAI

QSDLI-016AEN(CE)

The design and specifications are subject to change without prior notice for product improvement. Consult with the sales agency or manufacturer for details.

16122500000090

20150122

kaisai.com