

# SMART AC

OWNER'S MANUAL

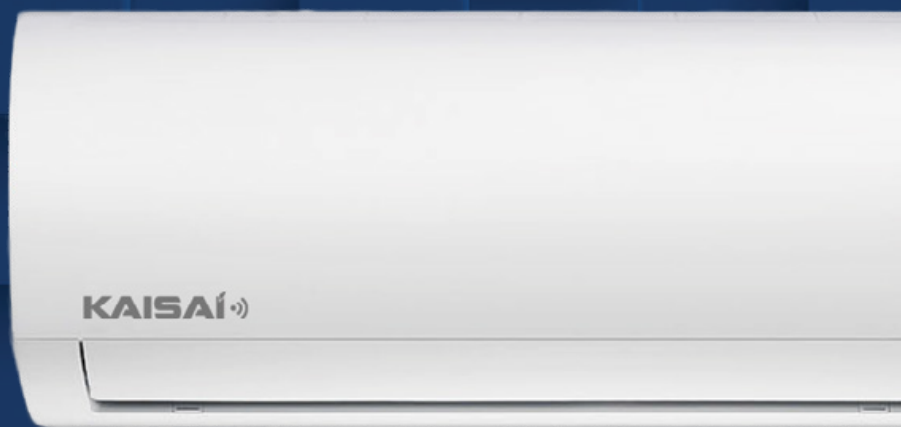

**KAISAI**

**KAISAI**

# **SMART AC KIT**

## Owner's Manual

**IMPORTANT NOTE:**

Read the manual carefully before installing or connecting your Smart kit. Make sure to save this manual for future reference.

# CONTENS

<b>1. Specification.....</b>	.....
<b>2. Precautions.....</b>	.....
<b>3. Download and install app.....</b>	.....
<b>4. Install the smart kit.....</b>	.....
<b>5. User registration.....</b>	.....
<b>6. Network configuration.....</b>	.....
<b>7. How to use app.....</b>	.....
<b>8. Special functions.....</b>	.....
<b>9. Cautions.....</b>	.....

## DECLARATION OF CONFORMITY

Hereby, we declare that this AC is in compliance with the essential requirements and other relevant provisions of Directive 1999/5/EC. The declaration of conformity may be consulted with sales agent.

## 1. SPECIFICATION

**Model:** OSK102

**Standard:** IEEE 802.11b/g/n

**Antenna Type:** Wxternal omnidirectional Antenna

**Frequency:** WIFI 2.4G

**Maximum Transmitted Power:** Max. 15 dBm

**Operation Temperature:** 0°C~45°C/32°F~113°F

**Operation Humidity:** 10%~85%

**Power Input:** DC 5V/300 Ma

## 2. PRECAUTIONS

Applicable system: IOS, Android (Suggest:IOS 7.0, Android 4.0).

### NOTE:

- Due to special situation may be occurred, we explicitly claims below: Not all of the Andriod and IOS system are compatible with APP. We will not be responsible for any issue as a result of the incompatibility.

### Wireless safety strategy

- Smart kit only support WPA-PSK/WPA2-PSK encryption and none encryption . WPA-PSK/WPA2-PSK encryption is recommended.

### Caution

- Please Check The Service Website For More Information.
- Smart Phone camera needs to be 5 million pixels or above to make sure scan QR code well.
- Due to different network situation, sometimes, request time-out could happen, thus, it is necessary to do network configuration again.

- Due to different network situation, control process may return time-out sometimes. If this situation occurs, the display between board and App may not be the same, please do not feel confused.

**NOTE:** Company will not be liable for any issues and problems caused by Internet, Wi-Fi Router and Smart Devices. Please contact the original provider to get further help.

### 3. DOWNLOAD AND INSTALL APP

**Caution:** QR Code A and QR Code B is only available for downloading APP.

QR Code A



QR Code B



- Android Phone users: scan QR Code A or go to google play, search ,Nethome Plus' app and download it.
- Iphone Users: scan QR Code B or go to App Store, search ,Nethome Plus' app and download it.

### 4. INSTALL THE SMART KIT

1. Remove the protective cap of the smart kit.

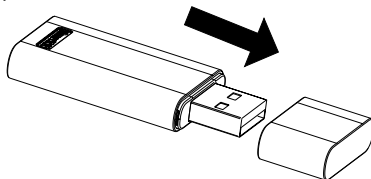

2. Open the front panel and insert the smart kit into the reserved interface.

3. Attach the QR code packed with SMART KIT to the side panel of the machine, ensure it is convenience to be scanned by the mobile phone. Alternatively, user can take picture of the QR Code and save in into their own phone.

**WARNING:** This interface is only compatible with SMART KIT provided by the manufacturer

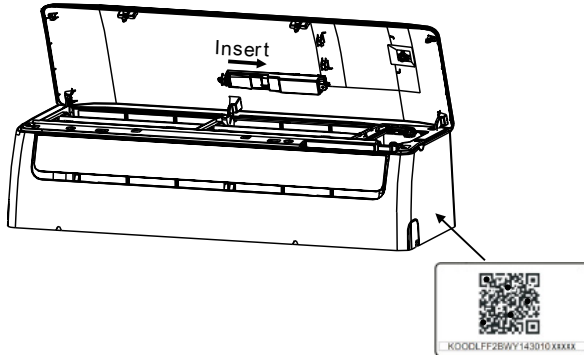

## 5. USER REGISTRATION

- Please ensure your mobile device is connected to Wifi router. Also, the Wifi router has already connected to Internet before doing user registration and network configuration.
- It is better to log in your email box and active your registration account by clicking link in case you forget the password.



1. Click "Create Account".

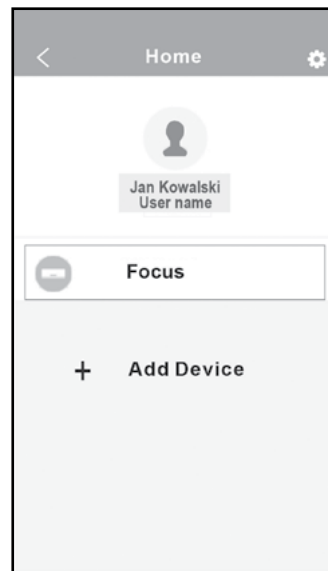

2. Enter your email address and password, and then click "Registration".

## 6. NETWORK CONFIGURATION

### Caution:

- It is necessary to forget any other around network and make sure the Android or IOS device just connect to the WIFI network you want to configure.
- Make sure the Android or IOS device WIFI function works well and can be connected back to your original WIFI network automatically.

### Kindly reminder:

When AC enters into AP mode, the air-conditioning remote controller can't control it. It is necessary to finish network configuration or power the AC again in order to control it. Alternatively, you need to wait 8 minutes to let the AC quit AP mode automatically.

## USING ANDROID DEVICE TO DO NETWORK CONFIGURATION

1. Make sure your mobile device has already been connected to the wifi network which you want to use. Also, you need to forget other irrelative wifi network in case it influences your configuration process.
2. Disconnect the power supply of AC.
3. Connect the power supply of AC, and seven times press the „LED” button in the remote control.
4. When the AC displays AP, it means that the AC WIFI has already entered into AP Mode.

Some type of AC do not need the **2** step to be in AP mode.

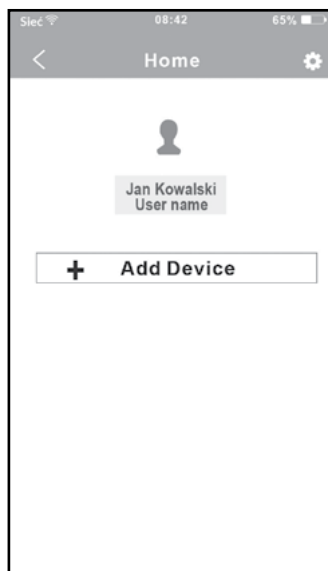

5. Press “+Add Device”.



6. Scan QR Code which is packed with smart kit.

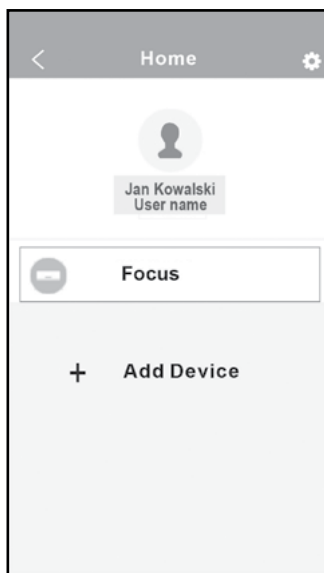

7. Select your own WiFi network, for example My Home (the picture is only for reference).
8. Enter your own WiFi router password and click OK.

9. Configuration Success, you can see the device on the list.

## USING IOS DEVICE TO DO NETWORK CONFIGURATION

1. Mak sure your mobile device has already been connected to the wifi network which you want to use. Also, you need to forget other irrelative wifi network in case it influences your cofiguration process.
2. Disconnect the power supply of AC(some units).
3. Connect the power supply of AC, and continuously press the digital display button or do not disturb button seven times in 3 minutes.
4. When the AC displays "AP" , it means that the AC WIFI has already entered into AP Mode.

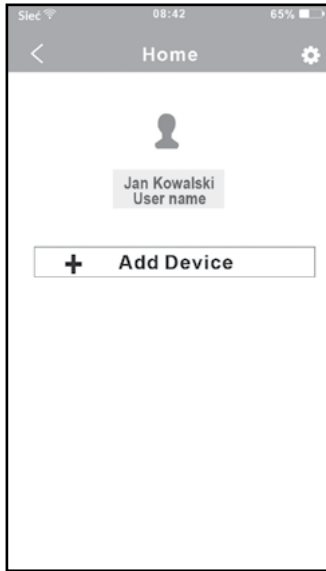

5. Press "+Add Device".



6. Scan QR Code which 9 is packed with smart kit.

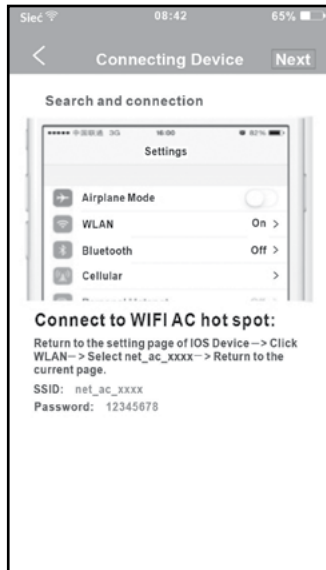

7. Read the instruction above and press the Home button to return to the device interface.

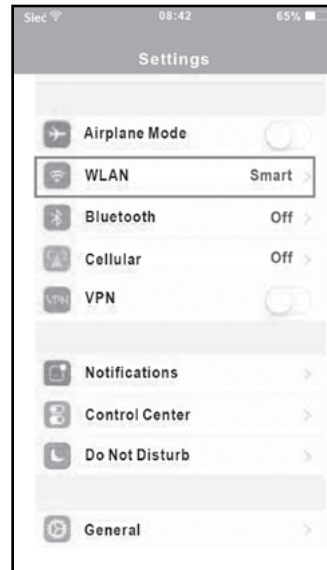

8. Click settings to enter the setting page, select WLAN/WIFI.



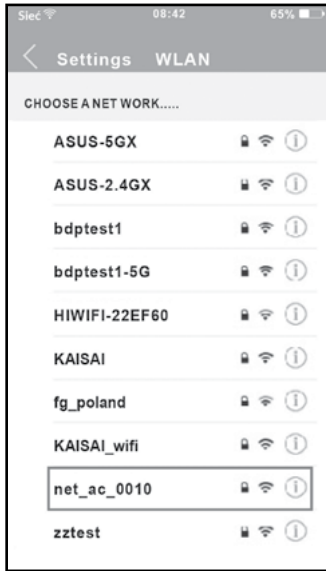

10. Choose net\_ac\_XXXX.

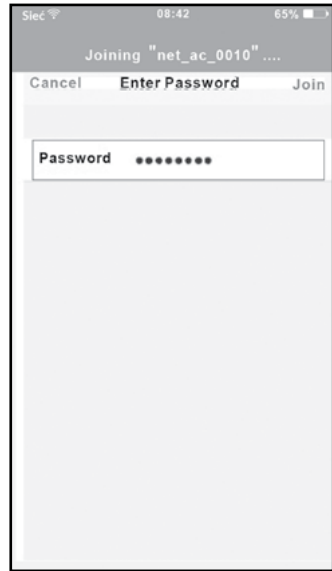

10. Type default password: 12345678 and click "Join".

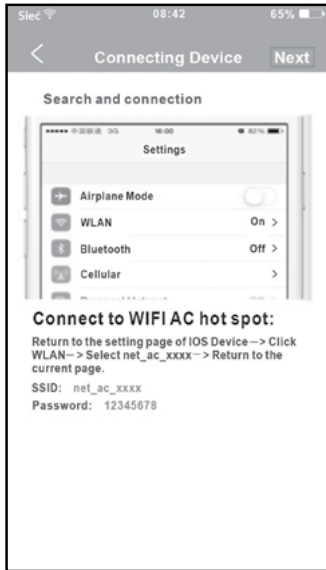

11. Return to APP and click Next.



12. Select your own WiFi network, for example My Home (the picture is only for reference).  
13. Enter your own WiFi router password and click OK.

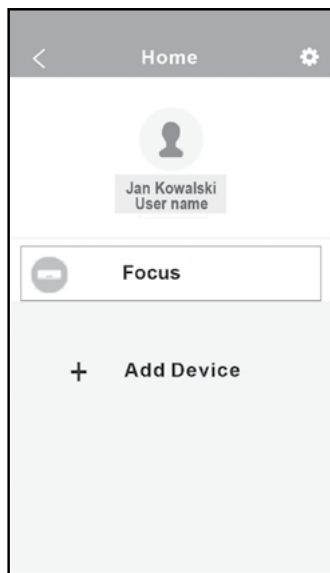

14. Configuration Success, you can see the device on the list.

**NOTE:**

When finishing network configuration, APP will display success cue words on the screen.

Due to different internet environment, it is possible that the device status still display offline. If this situation occurs, it is necessary to pull and refresh the device list on the APP and make sure the device status become online. Alternatively, user can turn off the AC power and turn on it again, the device status will become online after few minutes.

**7. HOW TO USE APP**

Please ensure both your mobile device and air conditioner are connected to the Internet before using app to control the air conditioner via internet, please follow the next steps:



1. Type your own account and password, Click "Sign in".

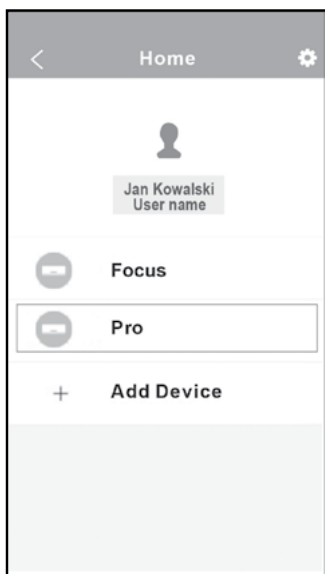

2. Select the target air conditioner to enter into the main control interface.

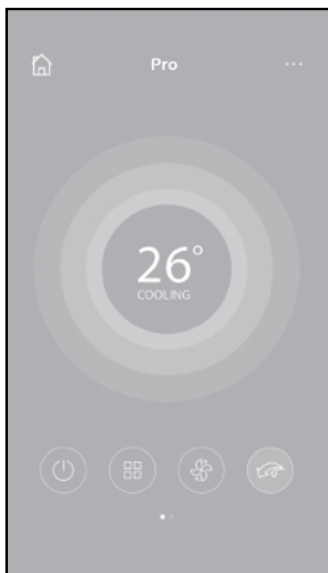

3. Thus, user can control air conditioners on/off status, operation mode, temperature, fan speed and so on.

**NOTE:**

Not all the function of the APP is available on air conditioner. For example: ECO, Turbo, Left and Right Swing, Up and Down swing function, please check the user manual to find more information

**8. SPECIAL FUNCTIONS**

Including: Timer on, Timer off, 8OC Heat, Sleep, Check.

**NOTE:** If the air conditioner do not support the above function, the function will be hid from the function list.

**Timer on/Timer off**

Weekly, user can make an appointment to turn on or off AC on specific time. User also can choose circulation to keep the AC under schedule control every week.

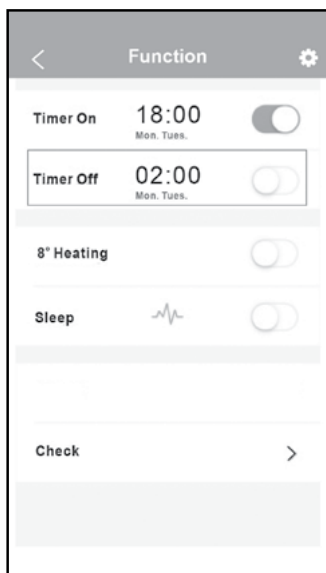
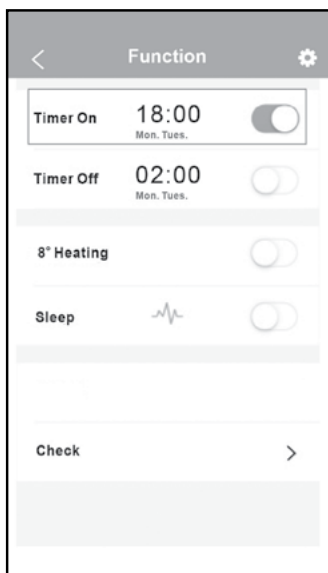

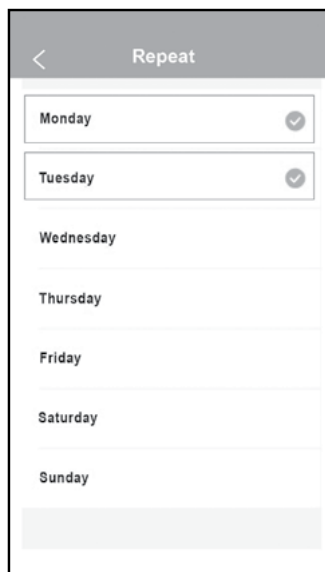
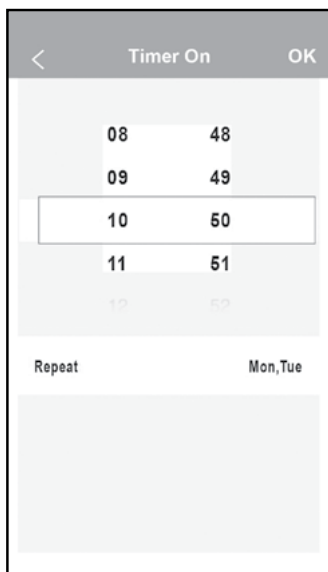

## 8°C HEAT

User can let the AC run under 8°C Heat by one-click. When people go outside, this function can protect your furniture from frost damage.

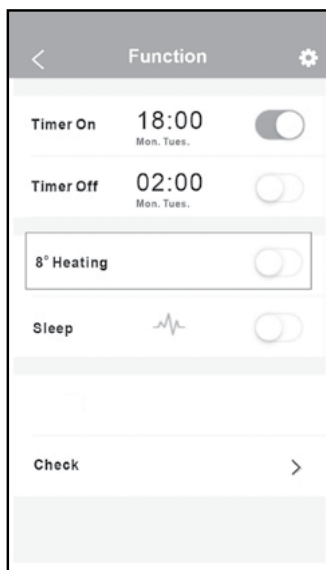

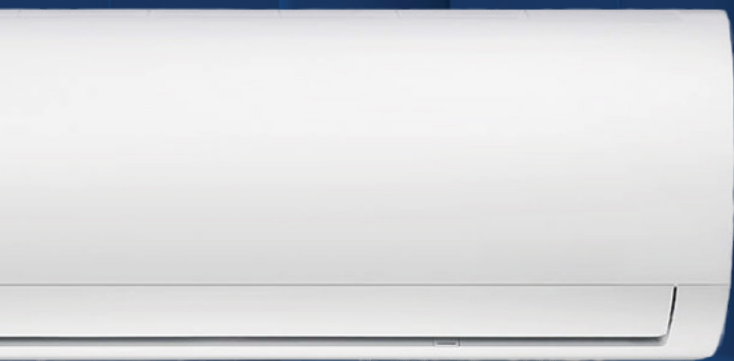

**KAISAI EUROPE** ul. Ostrobramska 101 A, 04-041 Warszawa | tel. (22) 517 36 00, fax (22) 879 99 07 | [kaisai.com](http://kaisai.com)

**KAISAI**