

KAISAI





OWNER'S MANUAL

XK60 WIRED CONTROLLER

User Notice

Please carefully read this manual before installation and use of this product. Thanks for choosing FGPOLAND duct type air conditioners. Please read this manual carefully before operating this product and keep it properly for future reference. In addition, please take notice of the symbols below.

 WARNING!	This mark indicates procedures which, if improperly performed, might lead to the death or serious injury of the user.
 CAUTION!	This mark indicates procedures which, if improperly performed, might possibly result in personal harm to the user, or damage to property.

 CAUTION!
Do not install the wired controller in the damp place or under direct sunlight.
Do not beat, toss, or frequently assemble/disassemble the wired controller.
Do not operate the wired controller with wet hands and never let any liquid flow into it.
Do not install or remove the wired controller by yourself. If necessary, please contact the after-sales serviceman.
This wired controller is applicable to various kinds of air conditioners, while some specific functions unavailable to the duct type air conditioners will not be covered in this manual.
Before operating the air conditioner, please read this manual carefully and keep it properly for future reference.

1 Introduction to the Wired Controller

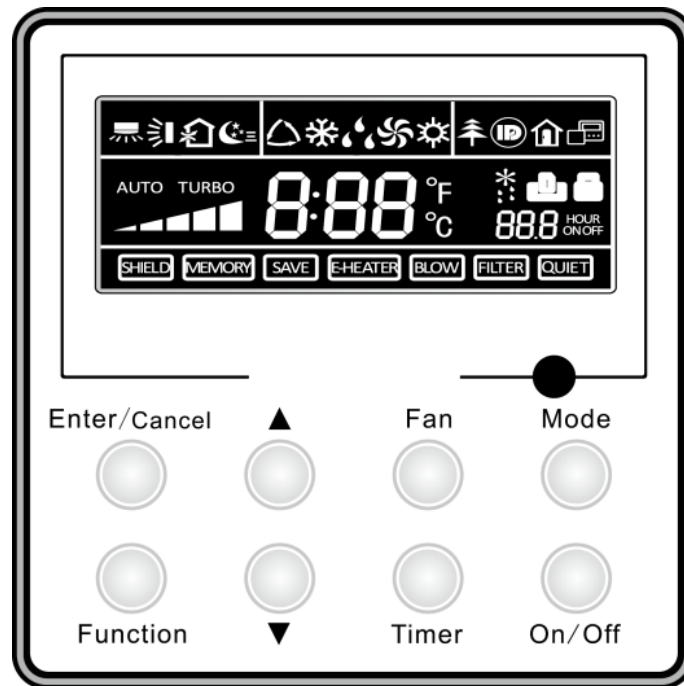

Fig.1 Appearance of the Wired Controller

1.1 Appearance and LCD Icons

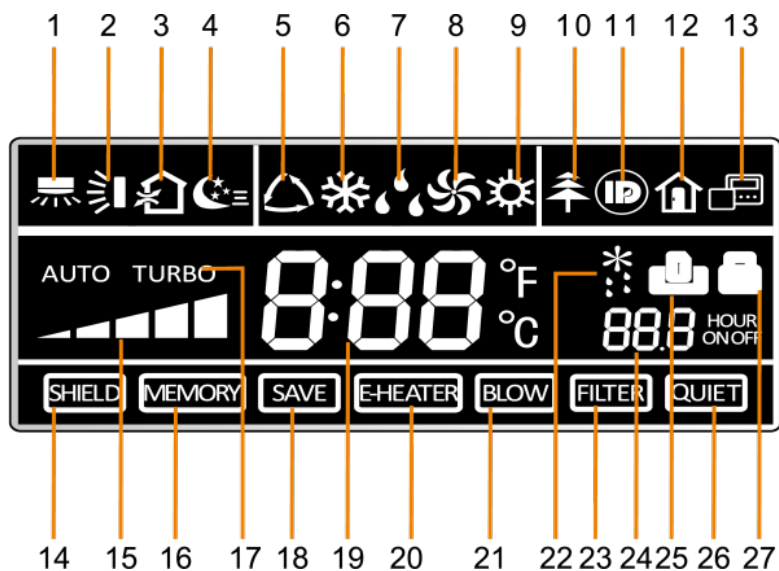





























Fig.2 Appearance of the LCD

1.2 Introduction to the LCD Icons

Table 1

No.	Icons	Introduction
1		Left and right swing function
2		Up and down swing function
3		Air exchange function
4		Sleep function
5		Auto mode
6		COOL mode
7		DRY mode
8		FAN mode
9		HEAT mode
10		Health function
11		I-Demand function
12		Vacation function
13		Status display of master and slave wired controller
14		Shield function The button operation, temperature setting, "On/Off" operation, "Mode" setting, and "Save" setting are disabled.
15		Fan speed
16		Memory function The unit will resume the original setting state after power recovery.
17		Turbo function
18		Energy-saving function
19		Ambient/setting temperature

20		Electric heater
21		Blow function
22		Defrosting function
23		Filter cleaning
24		Timer Setting
25		Keycard control / Detected status sensed by human body
26		Quiet function
27		Lock function

2 Press Buttons

2.1 Buttons

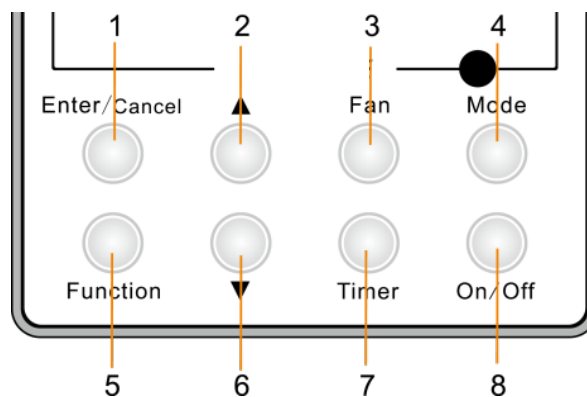

Fig.3 Press Buttons

2.2 Instruction to the Function of Press Buttons

Table 2

No.	Press Buttons	Function Introduction
1	Enter/Cancel	Function selection and canceling; Press it for 5s to enquiry the outdoor and indoor ambient temperature.
2	▲	Running temperature setting of indoor unit, range :16~30°C Timer setting, range:0.5-24hr Air function setting
6	▼	Save setting Clean setting

3	Fan	Select fan speed from high, mid-high, middle, mid-low, low and auto levels.
4	Mode	Selection of the COOL, HEAT, FAN, Auto or DRY mode.
5	Function	Switchover among these functions of SWING/AIR/SLEEP/HEALTH/I-DEMAND/VACATION/TURBO/SAVE/E-H EATER/BLOW/QUIET
7	Timer	Timer setting
8	On/Off	Turn on/off indoor unit
4 mode and 2 ▲	Memory	Press Mode and ▲ at the same time for 5s under the OFF state of the unit to activate/deactivate memory function (If memory is set, indoor unit will resume original setting state after power recovery. If not, indoor unit is defaulted to be OFF after power recovery. Memory function is defaulted to be ON)
2 ▲ and 6 ▼	Lock	Under the ON state of the unit without any malfunction or under the OFF state of the unit, press ▲ and ▼ buttons at the same time for 5s to go to the lock state. In this case, any other buttons won't respond the press. Repress ▲ and ▼ again for 5s to quit the lock state.
4 mode and 6 ▼	°F/°C	Under the OFF state of the unit, press the Mode and ▼ at the same time for 5s to switch the temperature scale between Celsius and Fahrenheit.

3 OPERATION INSTRUCTION

3.1 On/off

Press the On/Off button to turn on or off the unit.

Notes:

- ① The state shown in Fig.4 indicates the OFF state of the unit after energization.
- ② The state shown in Fig.5 indicates the ON state of the unit after energization.

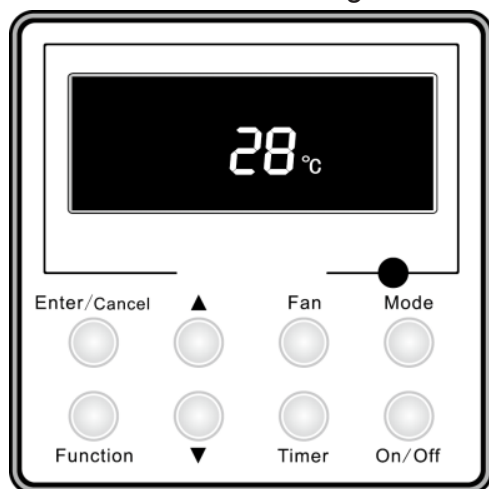

Fig.4 OFF State of the Unit

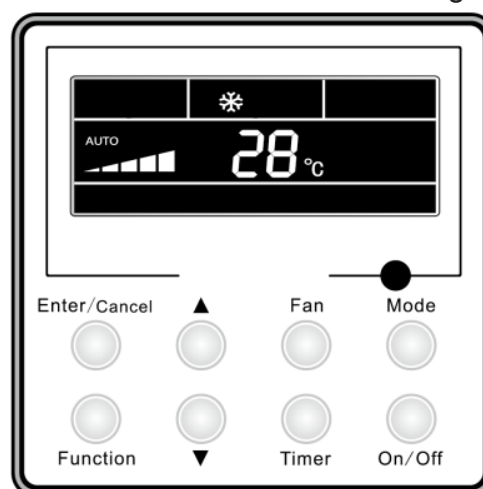

Fig.5 ON State of the Unit

3.2 Mode Setting

Under the ON state of the unit, press the Mode button to switch the operation modes as the sequence shown in Fig.6:

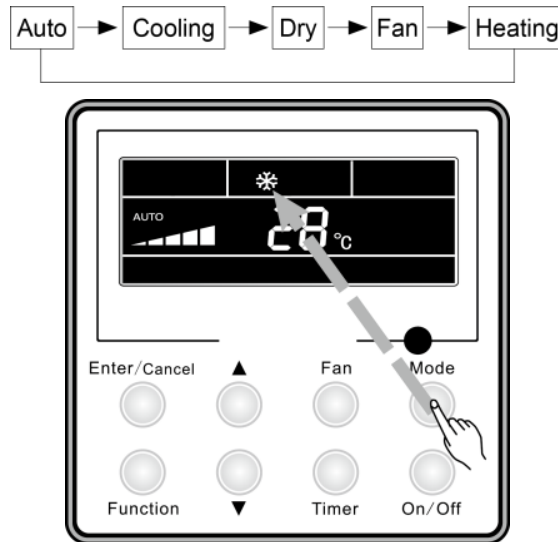

Fig.6

3.3 Temperature Setting

Press ▲ or ▼ button to increase or decrease setting temperature under on-state of the unit. If press either of them continuously, temperature will be increased or decreased by 1°C every 0.5s.

In Cooling, Dry, Fan and Heating mode, temperature setting range is 16°C~30°C.

In Auto mode, the setting temperature is un-adjustable.

As shown in Fig.7:

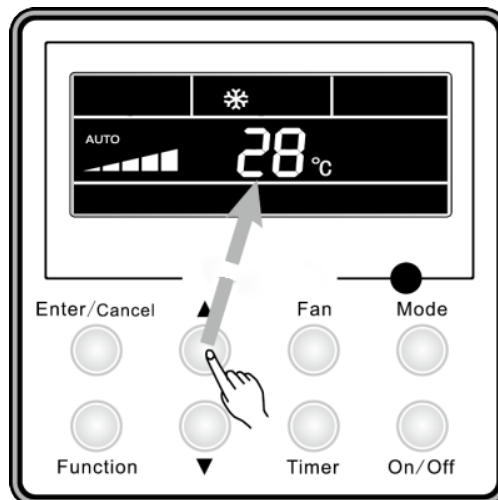

Fig.7 Temperature Setting

3.4 Fan Speed Setting

Press Fan button, fan speed of indoor unit will change as the sequence shown in Fig.8:

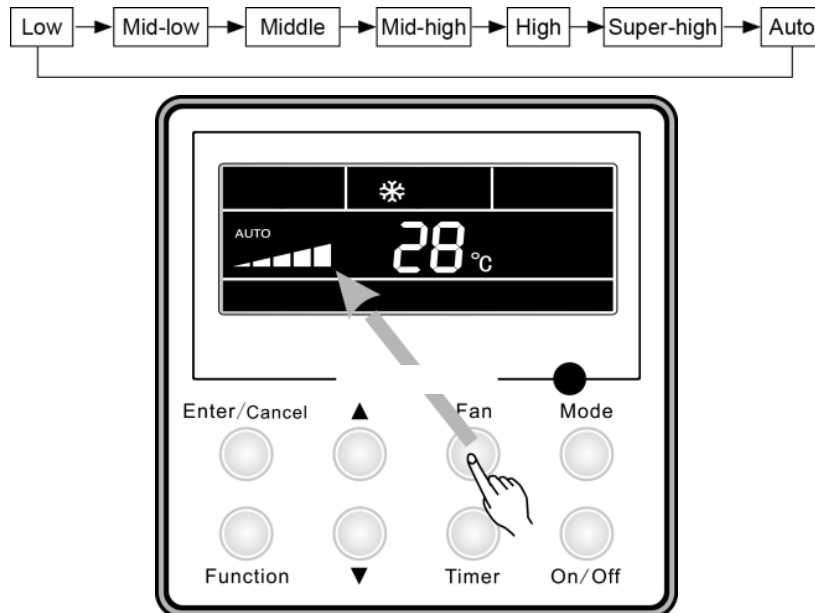

Fig.8 Fan Speed Setting

3.5 Right and Left Swing

Under the ON state of unit, press the Function button to select the “Right and Left Swing” function option and then press the Enter/Cancel button to activate it.

When the Swing function is activated, press the Function button to select the "Right and Left Swing" function option and then press the Enter/Cancel button to deactivate it.

Right and Left Swing function setting is as shown in Fig.9.

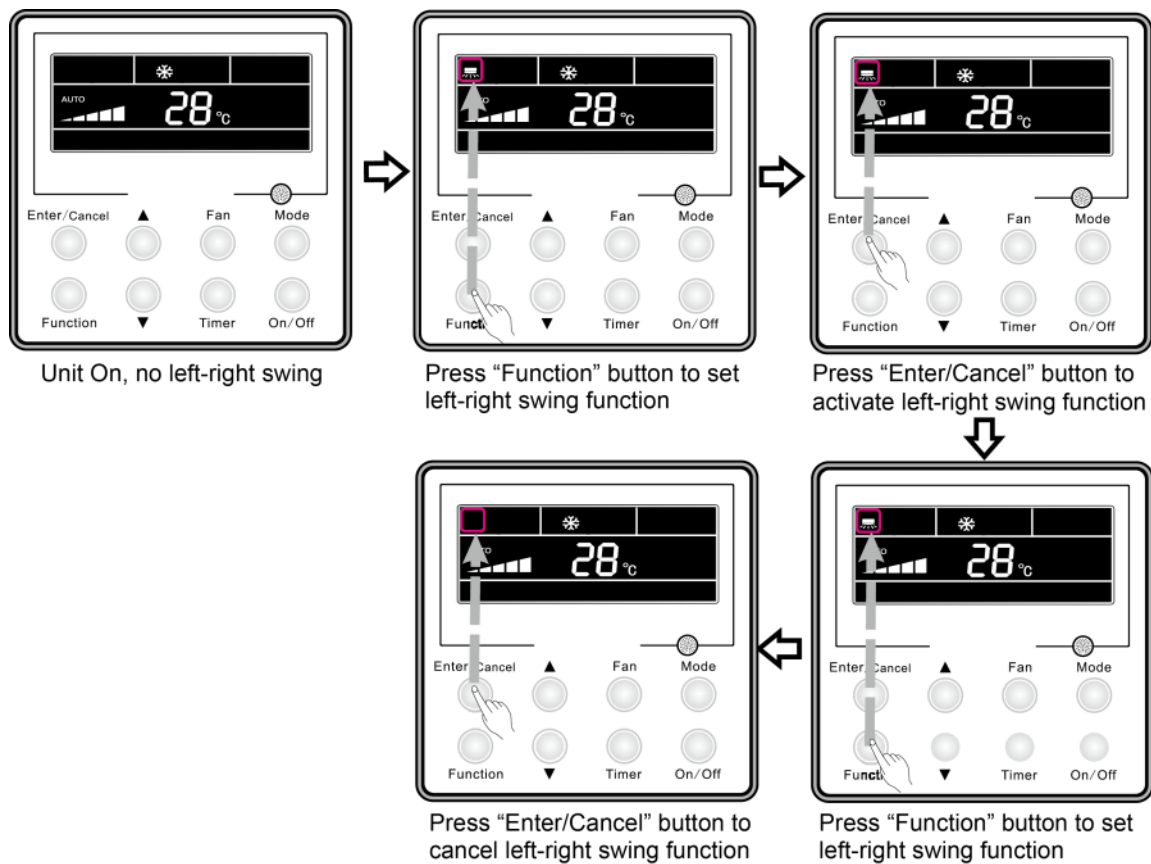

Fig.9 Right and Left Swing Setting

3.6 Up and Down Swing

Under the ON state of unit, press the Function button to select the "Up and Down Swing" function option and then press the Enter/Cancel to activate it.

When the Swing function is activated, press the Function button to select the "Up and Down Swing" function option and then press the Enter/Cancel button to deactivate it.

Up and Down Swing function setting is as shown in Fig.10.

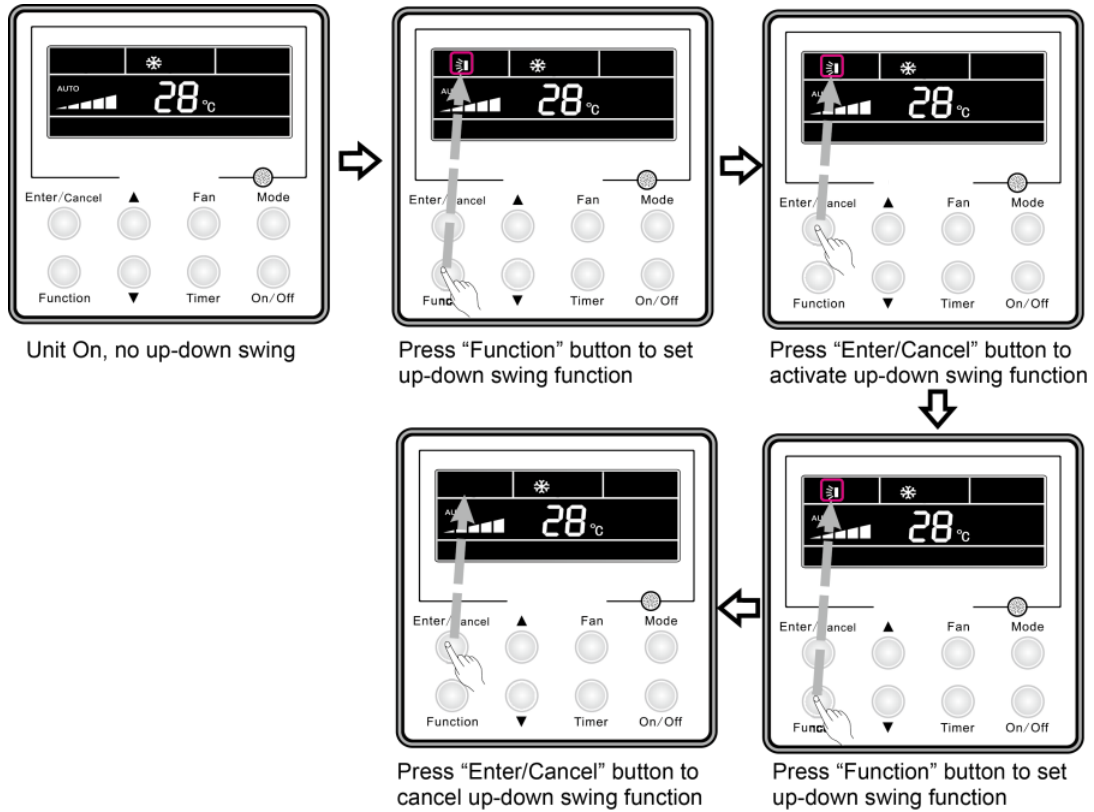

Fig.10 Up and Down Swing Setting

3.7 Timer Setting

Timer "On" Setting:

It is intended to set when to start the unit. When the unit is OFF, press the Timer button, with xx. Hour displayed and ON blinking, then press ▲/▼ to adjust the timer, after that, press the Timer button again to make a confirmation. If the Mode button is pressed prior to the confirmation, it will switch to the Timer Off setting. After the timer Off setting, the LCD displays xx. Hour ON OFF, xx. Hour indicating the time to start the unit, while the time to stop the unit won't be displayed.

Timer "Off" Setting:

It is intended to set when to stop the unit. When the unit is On, press the Timer button, with xx. Hour displayed and OFF blinking, then press ▲/▼ to adjust the timer, after that, press the Timer button again to make a confirmation. If the Mode button is pressed prior to the confirmation, it will switch to the Timer On setting. After the timer On setting, the LCD displays xx. Hour ON OFF, xx. Hour indicating the time to stop the unit, while the time to start the unit won't be displayed.

Cancellation of Timer Setting: The timer setting can be canceled by press "Timer". Then , xx. Hour won't be displayed.

Timer Setting under the ON state of the Unit is as shown in Fig.11:

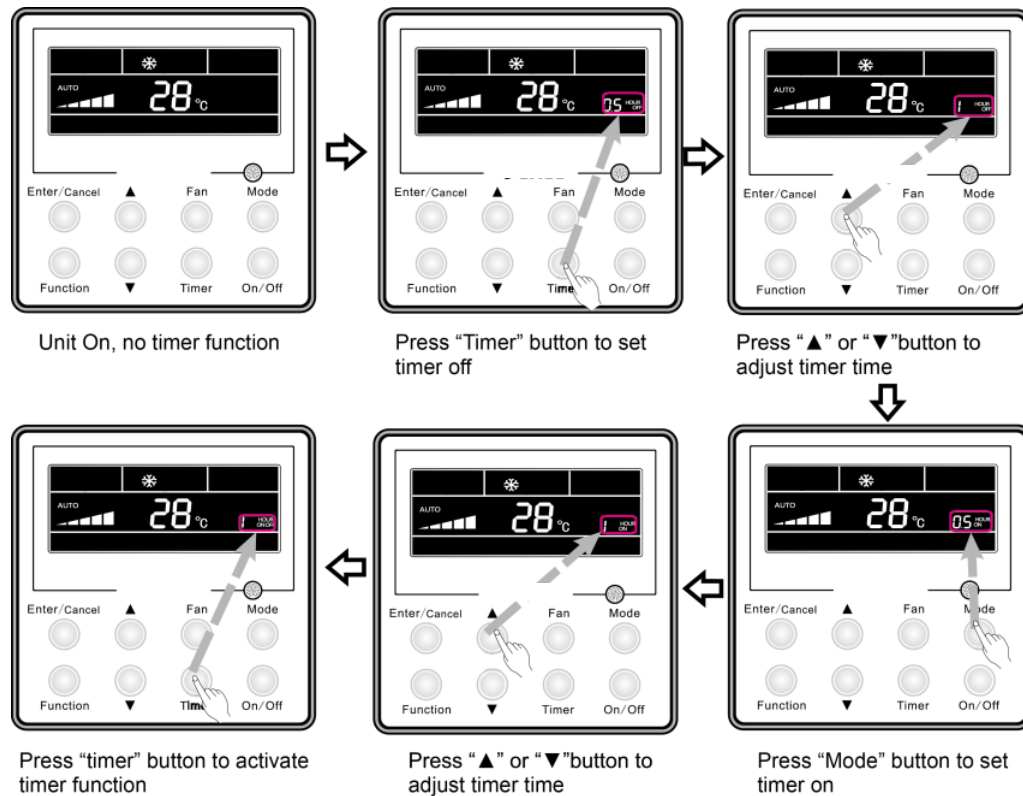

Fig.11 Timer Setting under the ON state of the Unit

Timer range: 0.5-24hr. Every press of the ▲ or ▼ button will make the setting time increased or decreased by 0.5hr. If press either of them continuously, the setting time will automatically increase/ decrease by 0.5hr every 0.5s.

Notes:

- ①. When Timer On and Timer Off both are set, the displayed time is the Timer On setting for the unit under the OFF state, or is the timer Off setting for the unit under the ON state.
- ②. Timer On setting starts when the unit under the ON state is turned off; Timer Off setting starts when the unit under the OFF state is turned on.

3.8 Air Exchange Setting

How to activate the air exchange function:

Under the ON state of the unit, press the Function button to select the "AIR" function, with the function symbol flashing, and then press ▲ or ▼ to adjust the "AIR" type, after that, press the Enter/Cancel button to activate this function. When this function is activated, the symbol will be displayed. Type 1 is the defaulted "AIR" type.

There are 10 "AIR" function types, but only 1-2 types are for the wireless remote

controller.

- 1—The unit continuously runs for 60min, and fresh air valve runs for 6 min.
- 2—The unit continuously runs for 60min, and fresh air valve runs for 12 min.
- 3—The unit continuously runs for 60min, and fresh air valve runs for 18 min.
- 4—The unit continuously runs for 60min, and fresh air valve runs for 24 min.
- 5—The unit continuously runs for 60min, and fresh air valve runs for 30 min.
- 6—The unit continuously runs for 60min, and fresh air valve runs for 36 min.
- 7—The unit continuously runs for 60min, and fresh air valve runs for 42 min.
- 8—The unit continuously runs for 60min, and fresh air valve runs for 48 min.
- 9—The unit continuously runs for 60min, and fresh air valve runs for 54 min.
- 10—The unit continuously runs for 60min, and fresh air valve always runs.

How to deactivate the air exchange function:

When the “Air” function is activated, it can be deactivated in the way by firstly pressing the Function button to select the “Air” function option with the “Air” symbol flashing, and then pressing the Enter/Cancel button with the “Air” symbol disappeared.

Air Exchange setting is shown as in Fig.12:

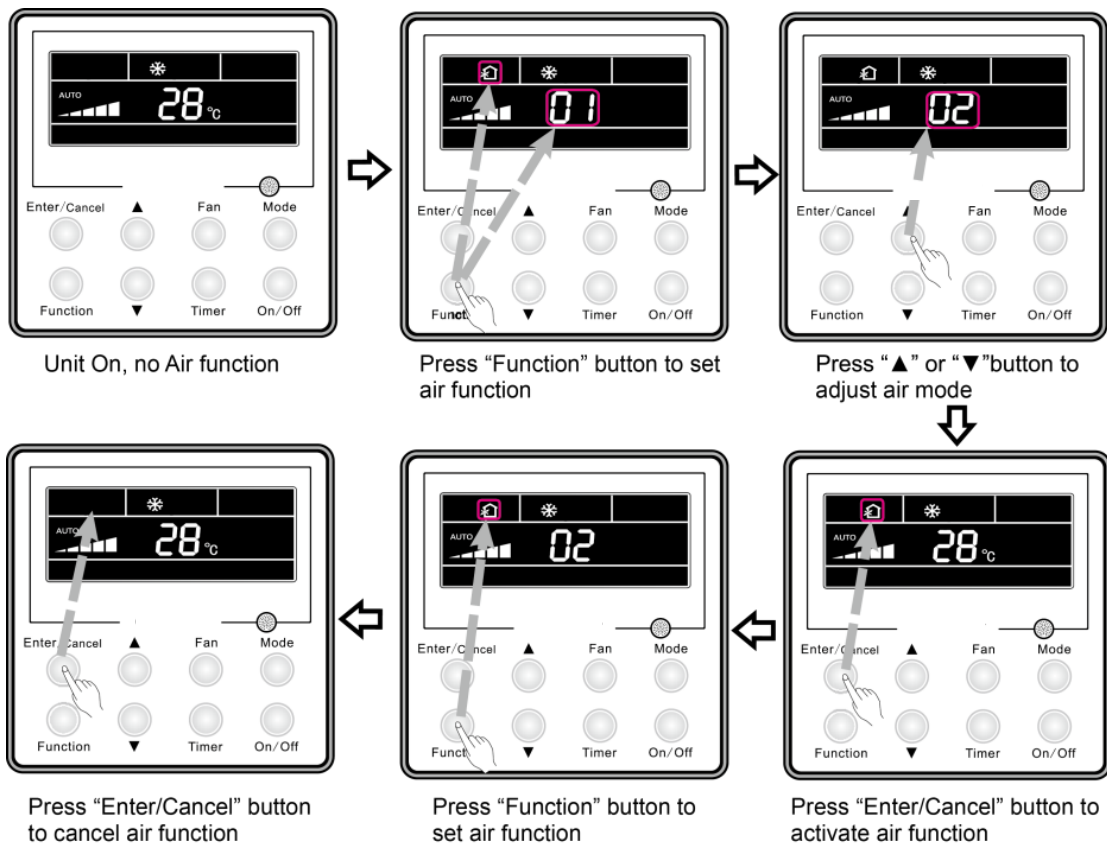

Fig.12 Air Exchange Setting

3.9 Sleep Setting

Sleep on: Press the Function button under the ON state of the unit to select the “Sleep” function option and then press the Enter/Cancel button to activate it.

Sleep off: When the Sleep function is activated, press the Function button to select the Sleep function option and then press the Enter/Cancel button to deactivate this function.

Sleep setting is as shown in Fig.13 :

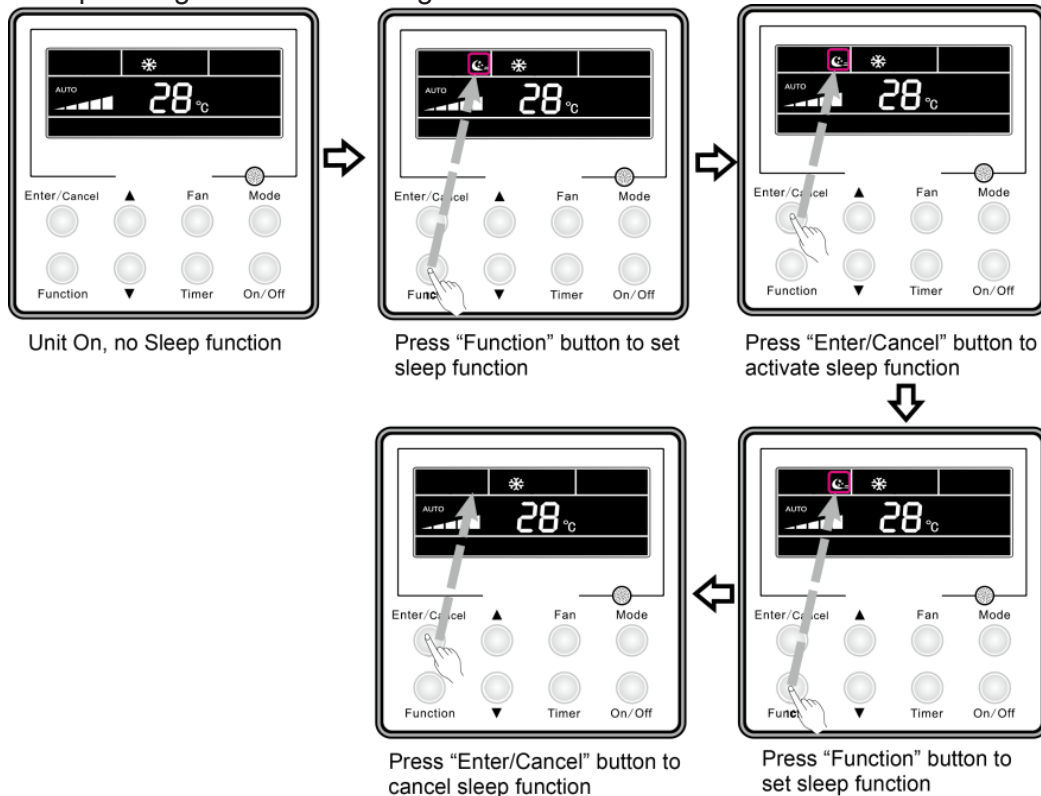

Fig.13 Sleep Setting

Notes:

- ①. The Sleep function is defaulted to be OFF after power recovery.
- ②. The Sleep function is unavailable under the Fan mode.
- ③. When the Quiet function is activated, the Quiet function will always keep ON no matter if the Sleep function is activated or deactivated.
- ④. Under the Cool mode, the Sleep function is ON, the setting temperature range can be 16~23°C, 24~27°C, 28~29°C or 30°C. Each of them has a different curve as shown in Fig.14.

e.g. If the setting temperature is 25°C, the temperature will rise by 1°C in each hour until it reaches 27°C. 7 hours later, the temperature will drop to 26°C. After that, the unit will run at this temperature.

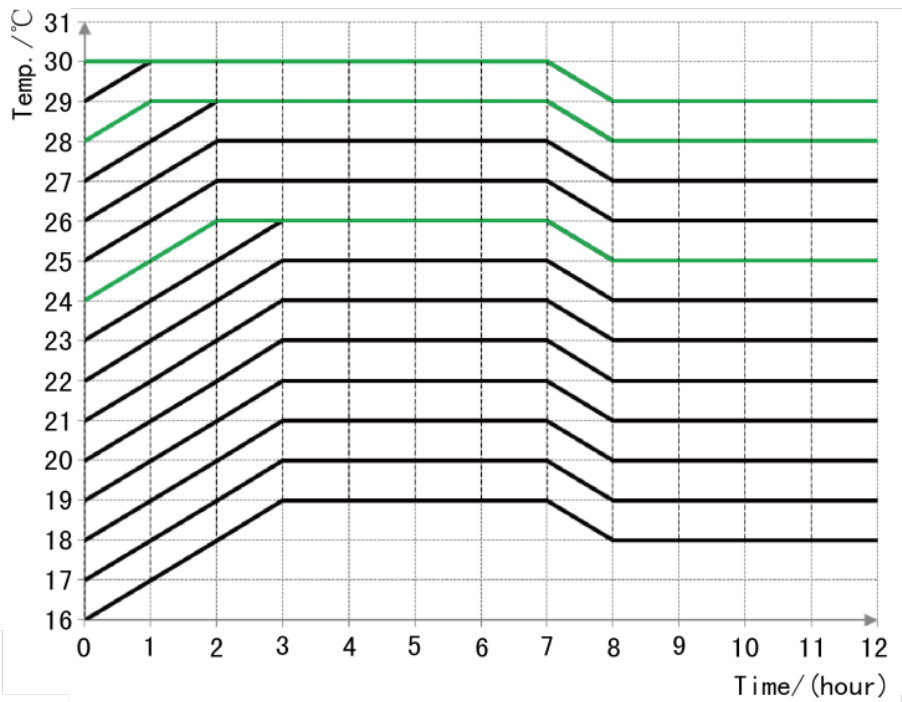

Fig.14 Sleep Curve under the COOL Mode

Under the Heat mode, the Sleep function is ON, the setting temperature range can be 16°C, 17~20°C, 21~27°C or 28~30°C. Each of them has a different curve as shown in Fig.15.

e.g. If the setting temperature is 22°C, the temperature will drop by 1°C in each hour until it reaches 20°C. Then, the unit will run at this temperature

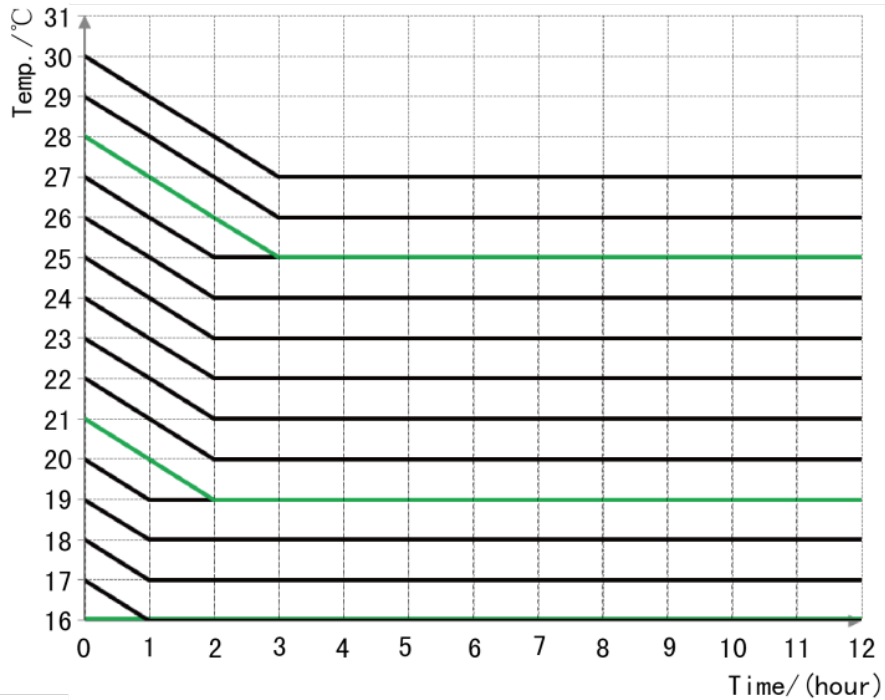

Fig.15 Sleep Curve under the HEAT Mode

3.10 Health Setting

Under unit on status, press “Function” button to select health function with “Health” icon flashing. Press “Enter/Cancel” button to activate health function.

When health is on, press “Function” button to set function, with “health” icon flashing. Then press the “Enter/Cancel” button to cancel health function.

How to set health function is shown in the Fig.16:

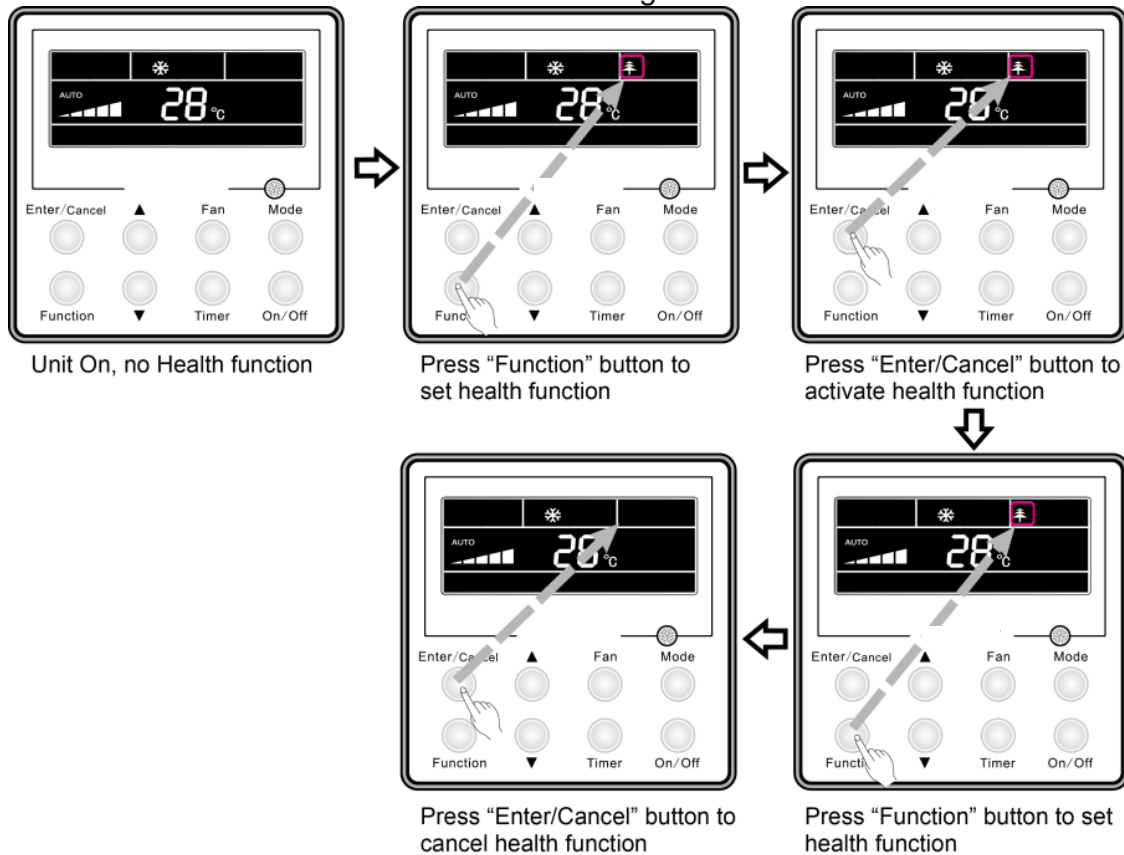

Fig.16 Health Setting

Note:

- ①. The health function can be cancelled by turning off the unit.
- ②. The health function can not be cancelled by mode switching.
- ③. After the unit is resumed, health function will be maintained.

3.11 I-Demand Setting

Under cooling mode, press “Function” button to select I-Demand function with “I-Demand” icon flashing. Press “Enter/Cancel” button to activate I-Demand function.

It will display the icon of I-Demand, and “5E” will be displayed on the temperature display area.

When I-Demand is on, press “Function” button to set function, with “I-Demand”

icon flashing. Then press the “Enter/Cancel” button to cancel I-Demand function.

How to set I-Demand function is shown in the Fig.17:

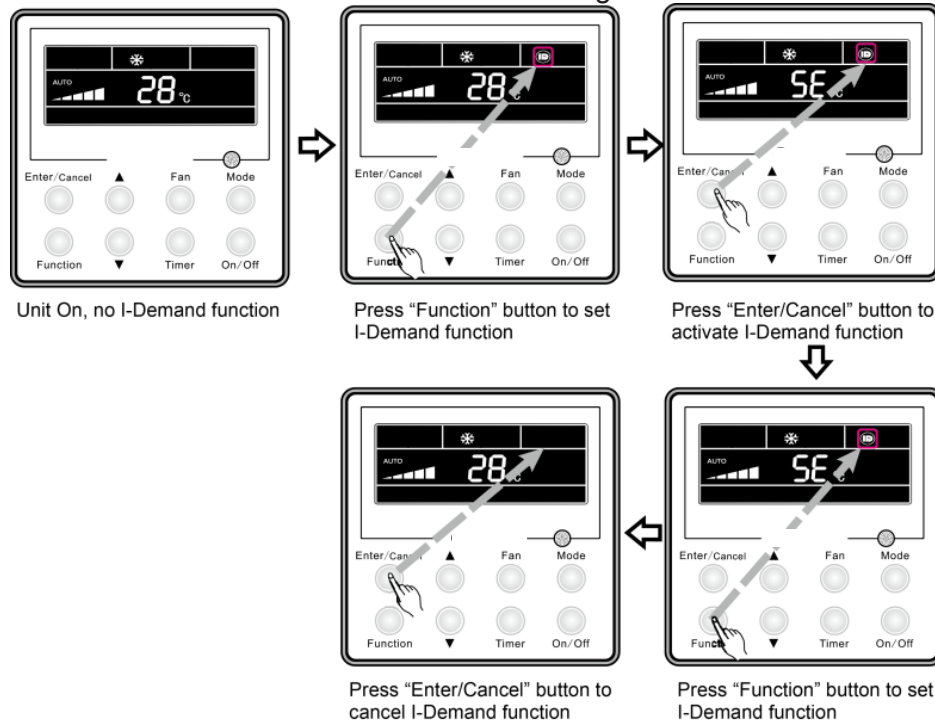

Fig.17 I-Demand Setting

Note:

- ①. The I-Demand function can be cancelled by mode switch and unit ON/OFF.
- ②. After the unit is resumed, I-Demand function will be maintained.
- ③. The I-Demand function can not be simultaneously set and can be cancelled by Sleep/Quiet function.
- ④. When the I-Demand function is set, the unit will run as per Auto fan speed. The Turbo fan speed is not available.
- ⑤. When the I-Demand function is set, the setting temperature 27°C can not be changed.
- ⑥. When the setting temperature is shielded by the distant control, I-Demand function can not be entered.

3.12 Vacation Setting

Vacation function: It’s used to keep the indoor ambient temperature and activate fast heating.

Under heating mode, press “Function” button to select Vacation function with “Vacation” icon flashing. Press “Enter/Cancel” button to activate Vacation function.

When Vacation is on, press “Function” button to set function. Then press the

“Enter/Cancel” button to cancel Vacation function with no icon flashing.

How to set vacation function is shown in the Fig.18:

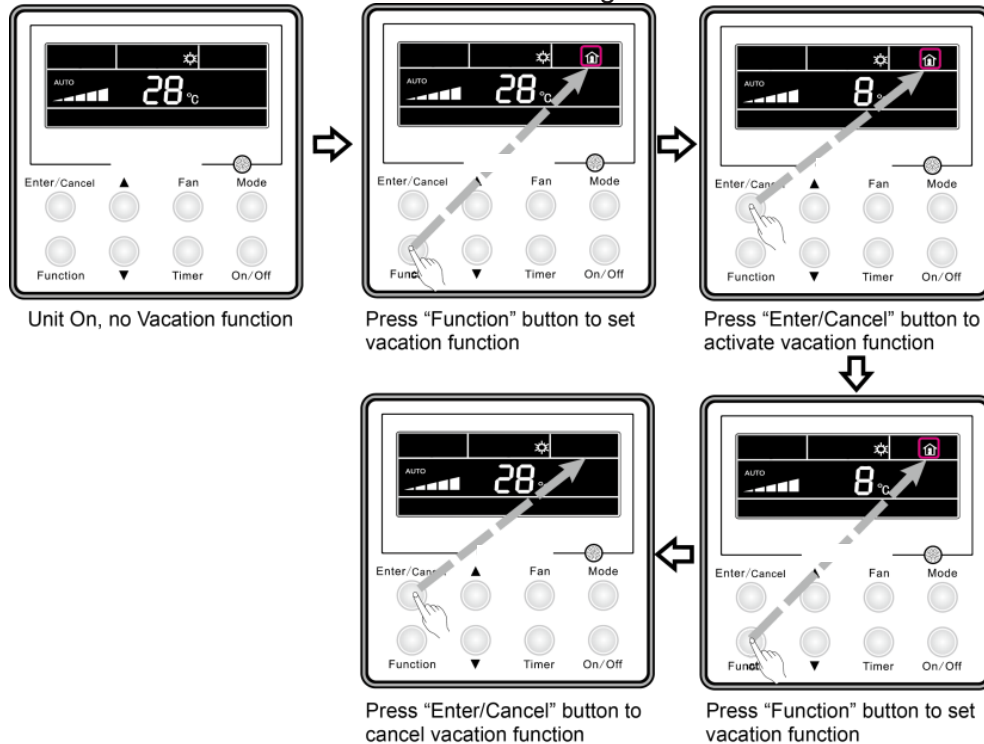

Fig.18 Vacation Setting

Note:

- ①. The vacation function can be only set under heating mode.
- ②. The turbo function will be cancelled when the vacation function is set.
- ③. The Sleep and Quiet function will be cancelled when the vacation function is set.
- ④. After the unit is resumed, the vacation function will be maintained.
- ⑤. When the vacation function is set, the setting temperature can not be shielded by the distant control. In reverse, the vacation function can not be set when the distant shielding is taking into effect.
- ⑥. When the vacation function is set, the setting temperature shown on the wired controller is 8°C. The indoor fan will automatically run as per Auto fan speed.
- ⑦. The vacation function can be cancelled when there is mode switching. The temperature will go back to the original setting temperature prior to vacation function.
- ⑧. Unit ON/OFF will not cancel the vacation function.

3.13 Turbo Function Setting

TURBO function: The unit at the highest fan speed can realize quick cooling or

heating so that room temperature can quickly approach the setting temperature.

In the COOL or HEAT mode, press the Function button to select the "Turbo" function option and then press the Enter/Cancel button to activate it.

When the "Turbo" function is activated, it can be deactivated by firstly pressing the Function button to select the "Turbo" option and then pressing the Enter/Cancel button.

Turbo function setting is as shown in Fig.19:

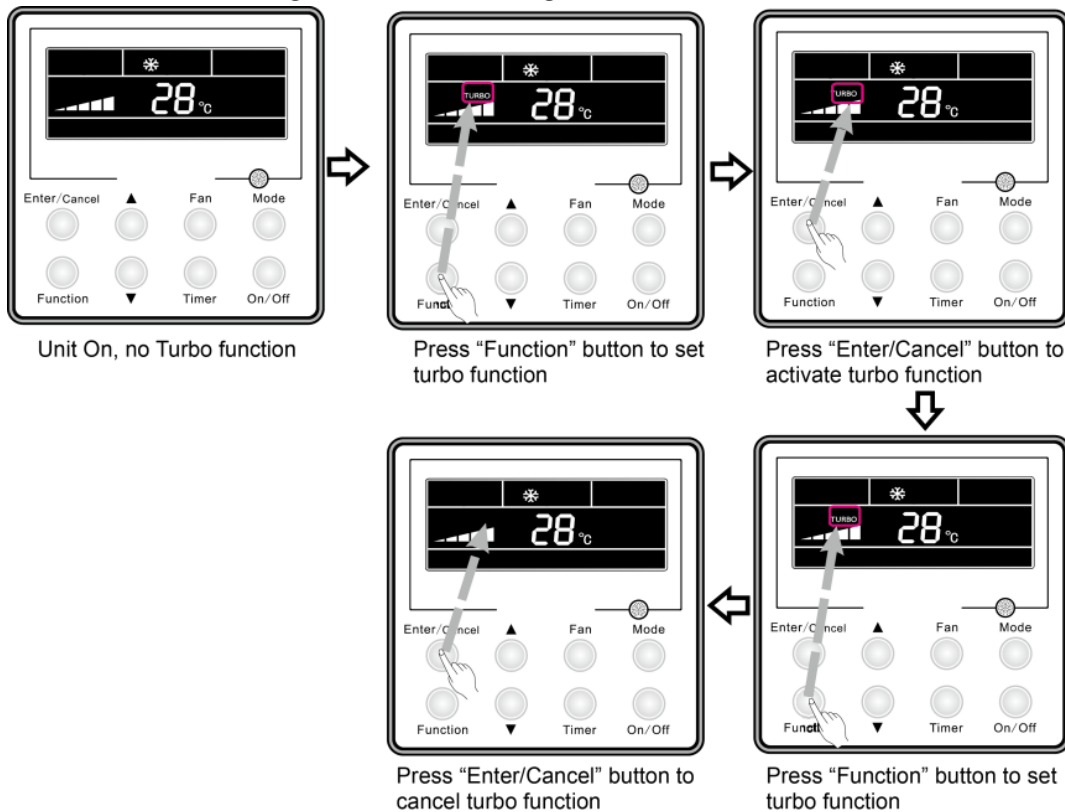

Fig.19 Turbo Function Setting

Notes:

- ①. The Turbo function will not be deactivated due to power failure. In DRY, FAN and AUTO modes, the Turbo function is unavailable and the function symbol won't be displayed.
- ②. The Turbo function will be automatically deactivated as the Quiet function is activated.
- ③. The FAN button can also be used to adjust Turbo function.

3.14 SAVE Function Setting

Energy Saving Function: Energy saving can make the air conditioner runs in a smaller temperature range by setting lower limited value of setting temperature in the COOL or DRY mode and upper limited value in the HEAT mode. As for the different batches of wired controllers, there are two kinds of setting method for SAVE function.

(1) Method 1 for setting SAVE function:

Energy Saving Setting for Cooling

When the unit runs under the COOL or DRY mode, press the Function button to select the “SAVE” function option, with “SAVE” flashing, and then press ▲ or ▼ to adjust the lower limit, after that, press the Enter/Cancel button to activate this function.

Energy Saving Setting for Heating

When the unit runs under the HEAT mode, press the Function button to select the “SAVE” function option, with “SAVING” flashing, then press the Mode button to switch to the “SAVE” setting for the HEAT mode and then press ▲ or ▼ to adjust the upper limit, after that, press the Enter/Cancel button to activate this function.

The activated SAVE function can be deactivated by firstly pressing the “Function” button to select the “SAVE” option and then pressing the “Enter/Cancel” button.

The energy saving setting is as shown in the Fig.20:

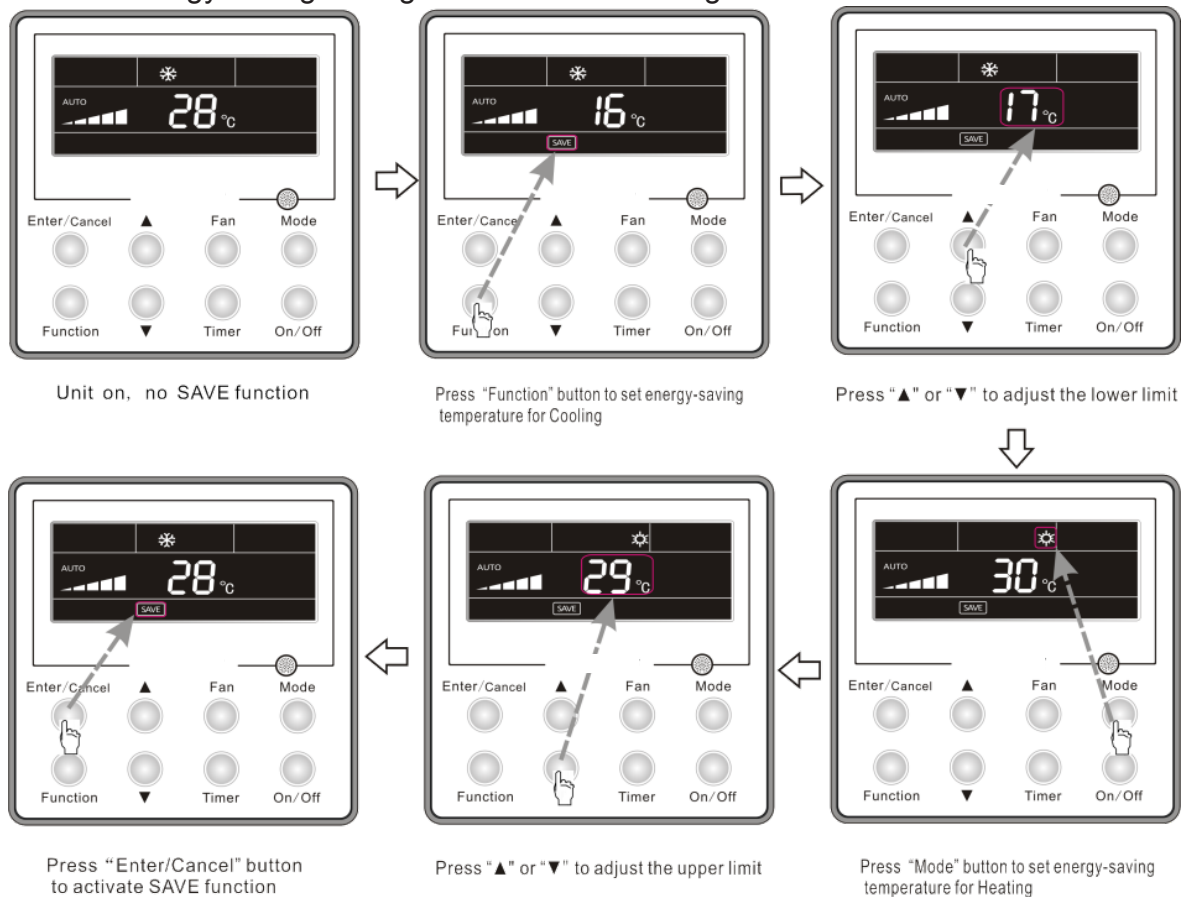

Fig.20 SE setting (1)

Notes:

- ①. Under the Auto mode, when the “SAVE” function is activated, the unit will forcibly quit the Auto mode and change to the current operation mode. Further, the “Sleep” function will be deactivated when the “SAVE” function is activated.

- ②. During the “SAVE” setting, if the Function button is pressed down or there is not any operation within 5s after the last button operation, the system will quit the “SAVE” setting with the current setting data not saved.
- ③. The “SAVE” function setting will be memorized in case of power failure.
- ④. The lower limit for cooling is 16 °C and the upper limit for heating is 30°C.
- ⑤. During the “SAVE” setting, if the expected setting temperature is out of the limit, then the limit temperature always prevail.

(2) Method 2 for setting SAVE function:

Under OFF status, press “timer” + “▲” buttons simultaneously for 5s to enter into the SAVE setting status. At this time, characters or icon of “SAVE” and cooling mode icon will be displayed; characters or icon of “SAVE” blinks, and upper and lower temperature will be displayed at the temperature area. Press “▲” and “▼” button to set upper and lower temperature limit (temperature setting range is 16—30 °C). Press “Mode” button to switch cooling and heating modes. As for the cooling only model, you can only set the lower temperature limit for the SAVE function under cooling mode. Under SAVE setting process, press “Enter/Cancel” or “Swing/Enter” button to save the set temperature for SAVE function and the SAVE status, and then SAVE function will be started up.

When SAVE function is started up, press “Timer” and “▲” buttons simultaneously again for 5s to cancel SAVE function.

SAVE setting under cooling or heating mode is shown in fig 21:

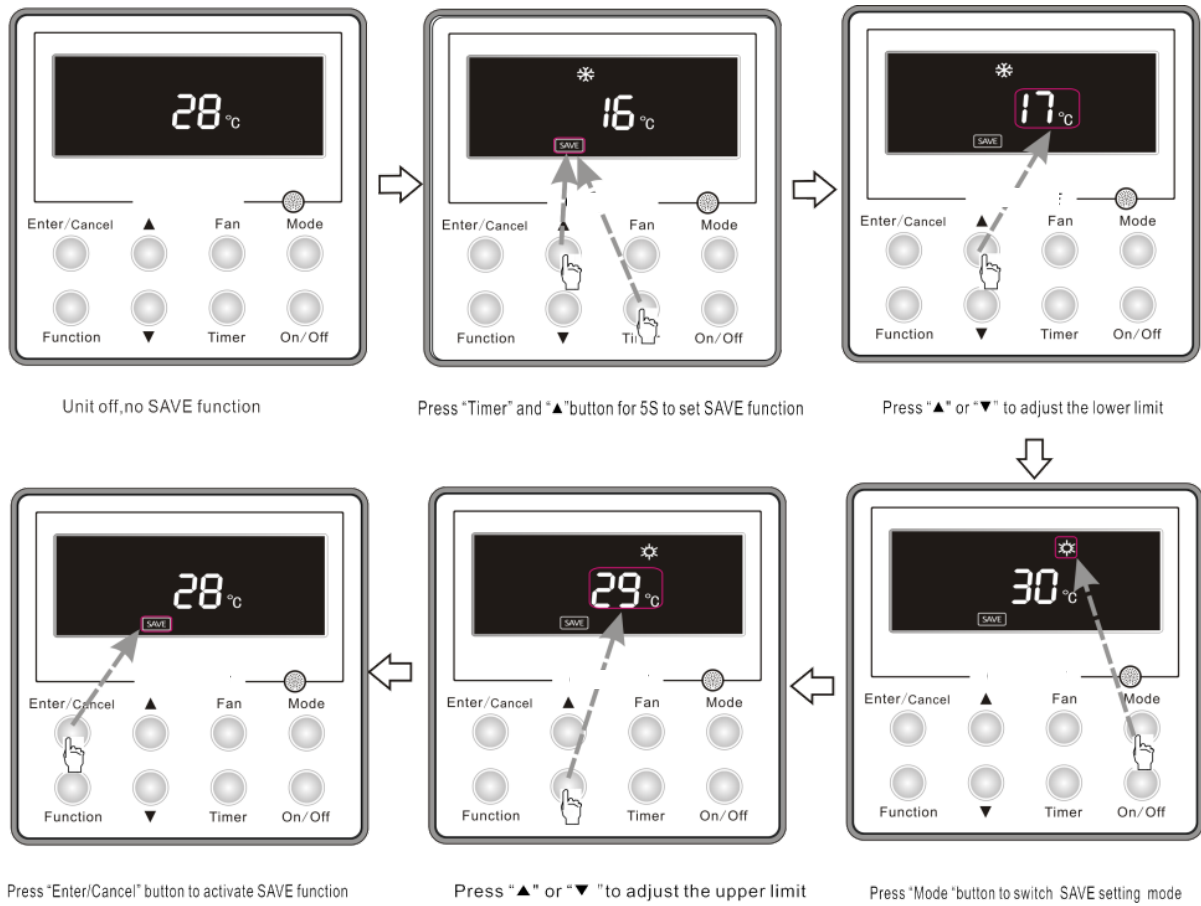

Fig.21 SE setting (2)

Notes:

- ①. If turn on SE function under AUTO mode, it will skip to related mode compulsively and then the SE function will be turned on;
- ②. Under SE function setting status, if there's no operation within 20s after the last button operation, the system will exit the SE function setting status. The current SE setting data won't be saved.
- ③. If power is resumed after power failure, SE setting function will be memorized;
- ④. The initial value of the minimum limit value for the set temperature under cooling mode is 16°C; the initial value of the maximum value for the set temperature under heating mode is 30°C;
- ⑤. After setting SE function, if the set temperature under all modes exceeds the SE setting range, it will select the corresponding limit value as the set temperature.
- ⑥. If press "▲" button when the set temperature is upper temperature limit, or press "▼" button when the set temperature is lower temperature limit, or the set temperature of the remote device is out of the limit, the characters or the icon of "SE" blinks for three times and the buzzer will give out a sound of twice.

3.15 E-HEATER Setting

E-HEATER: in the HEAT mode, “E-HEATER” function is allowed to be activated to improve the heating efficiency. Generally, it will be activated automatically as the unit goes into the HEAT mode through any button operations.

Activation of the “E-HEATER” Function: firstly press the Function button to select the “E-HEATER” option, with the symbol “E-HEATER” flashing, and then press the Enter/Cancel button to activate it. After the activation, the symbol “E-HEATER” will always be displayed.

Deactivation of the “E-HEATER” Function: firstly press the Function button to select the “E-HEATER” option, with the symbol “E-HEATER” flashing, and then press the Enter/Cancel button to deactivate it.

“E-HEATER” Function setting is as shown in Fig.22:

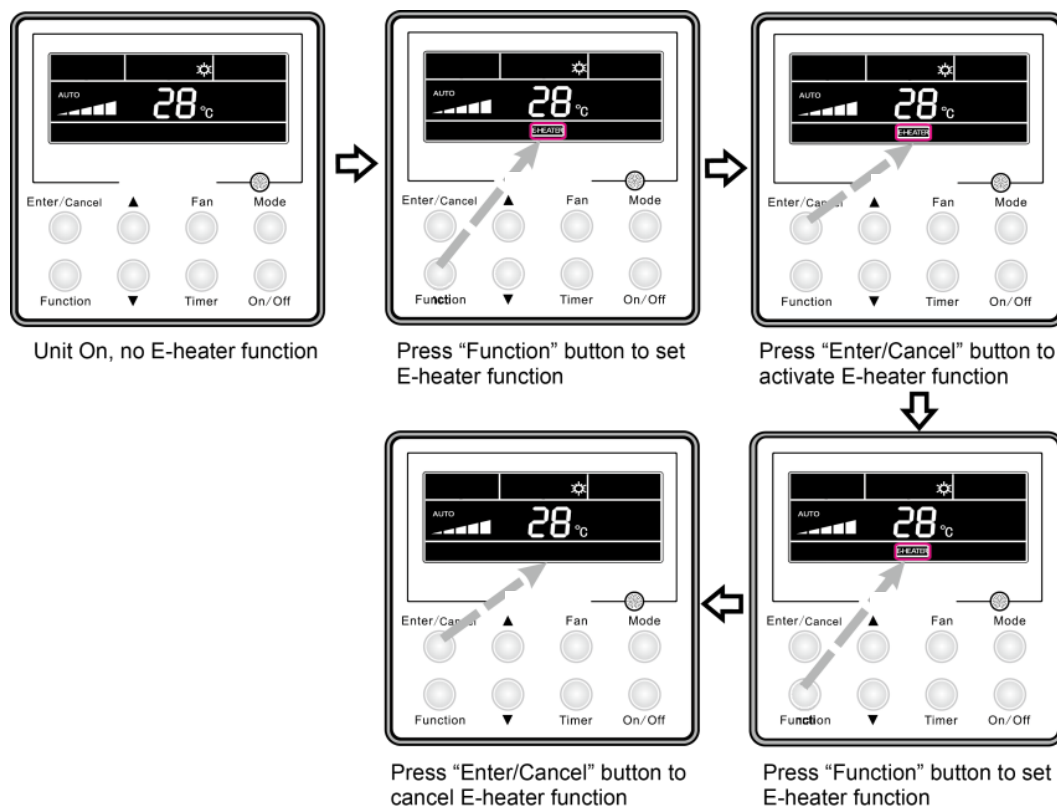

Fig.22 “E-HEATER” Function Setting

Note:

The “E-HEATER” function is not available in the COOL, DRY, and FAN modes, with the symbol “E-HEATER” not displayed.

3.16 Blow Function Setting

BLOW function: After the unit is turned off, water in evaporator of indoor unit will be automatically evaporated to avoid mildew.

Activation of the “Blow” Function: in the COOL or DRY mode, press the Function button to select the “Blow” option, with the symbol “BLOW” flashing, and then press the Enter/Cancel button to activate it.

Deactivation of the “Blow” Function: The activated “Blow” function can be deactivated by firstly pressing the Function button to select the “Blow” option and then pressing the Enter/Cancel button.

BLOW function setting is as shown in Fig.23:

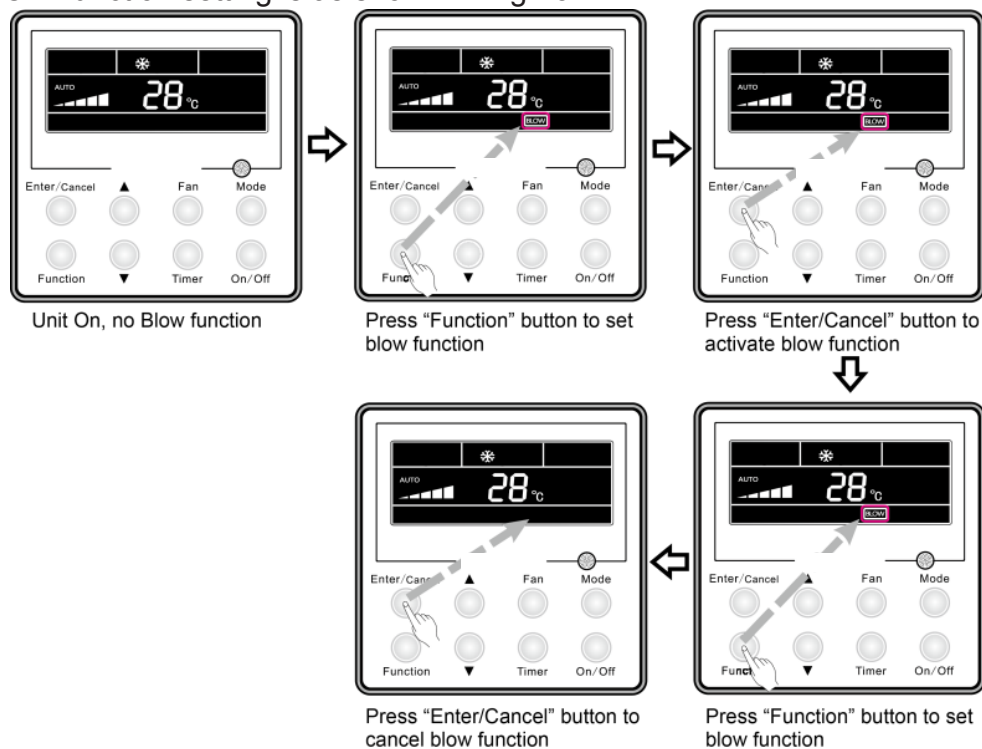

Fig.23 Blow Function Setting

Notes:

- ①. When the “Blow” function is activated, if the unit is turned off through the On/Off button, the indoor fan will still run at low fan speed for another 2 minutes. When the “Blow” function is deactivated, the indoor fan will stop directly as the unit is turned off.
- ②. The “Blow” function is not available in the FAN and HEAT modes.

3.17 Filter Setting

Under On status, press “Function” button to set “Filter” function with “Filter” icon flashing. The setting pollution level will be shown at the Timer area. Press “▲” and “▼”

to adjust pollution level and press “Enter/Cancel” button to activate Filter function.

When the Filter function is set, press “Function” button to set with “Filter” icon flashing. Press “▲” and “▼” to adjust till “00” is shown on the timer area. Then press “Enter/Cancel” button to cancel the Filter function.

How to set Filter function is shown in the Fig.24:

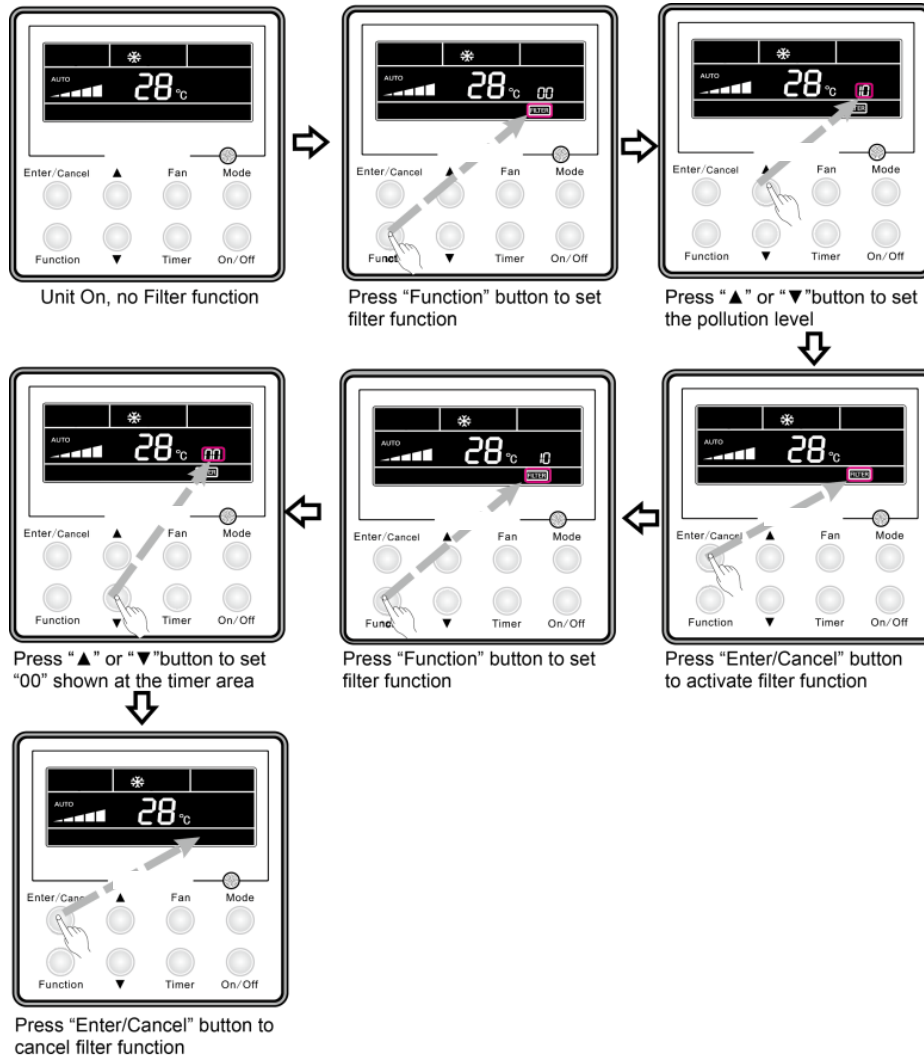

Fig.24 Filter Setting

While setting Filter, two numbers will be shown on the timer area. The first number represents the pollution level. The second number shows the accumulated operating time of the indoor fan. There are four statuses in total:

- ①. No Filter function setting ("00" shown at the timer area)
- ②. When the filter reaches light-level pollution, "1" will be shown at the first place, When "0" shows up at the second place, the accumulated operating hour reaches 5500h. Every increase of the number means another 500h is

accumulated. When “9” shows up, it means the operating hour reaches 10000h.



- ③. When the filter reaches middle-level pollution, “2” will be shown at the first place, When “0” shows up at the second place, the accumulated operating hour reaches 1400h. Every increase of the number means another 400h is accumulated. When “9” shows up, it means the operating hour reaches 5000h.
- ④. When the filter reaches serious-level pollution, “3” will be shown at the first place, When “0” shows up at the second place, the accumulated operating hour reaches 100h. Every increase of the number means another 100h is accumulated. When “9” shows up, it means the operating hour reaches 1000h.

Pollution level with corresponding operating hour:

Table 3

Pollution level	Accumulated operating time (h)	Pollution level	Accumulated operating time (h)	Pollution level	Accumulated operating time (h)
10	5500	20	1400	30	100
11	6000	21	1800	31	200
12	6500	22	2200	32	300
13	7000	23	2600	33	400
14	7500	24	3000	34	500
15	8000	25	3400	35	600
16	8500	26	3800	36	700
17	9000	27	4200	37	800
18	9500	28	4600	38	900
19	10000	29	5000	39	1000

Notes:

- ①. If the Filter function is effectively set, the  icon will light up.
- ②. If it is not necessary to clean the filter, no matter whether the setting is changed or not, the unit will not restart to timing while pressing “Enter/Cancel” button.
- ③. If the filter should be cleaned, under On/OFF status, the  icon will blink once every 0.5s so as to remind user to clean the filter. Press “Function” button to set with  icon flashing. Press “▲” and “▼” to adjust pollution

level, and then press “Enter/Cancel” button to activate it. If the setting pollution level is lighter than before, the **FILTER** icon will keep flashing. If the setting pollution level is more serious, the **FILTER** icon will go out, and the Filter function will keep on working.

- ④. The only method to cancel Filter function is, when the function is set with icon A flashing, let “00” shown at the timer area, at this time, the accumulated time will be zero clearing.

3.18 Quiet Function Setting

Press “Function” button to set Quiet function with its icon flashing. Press “Enter/Cancel” button to activate Quiet function.

When the quiet function is On, press “Function” button to set with Quiet icon flashing, press “Enter/Cancel” button to cancel Quiet function.

How to set Quiet function is set in the Fig. 25:

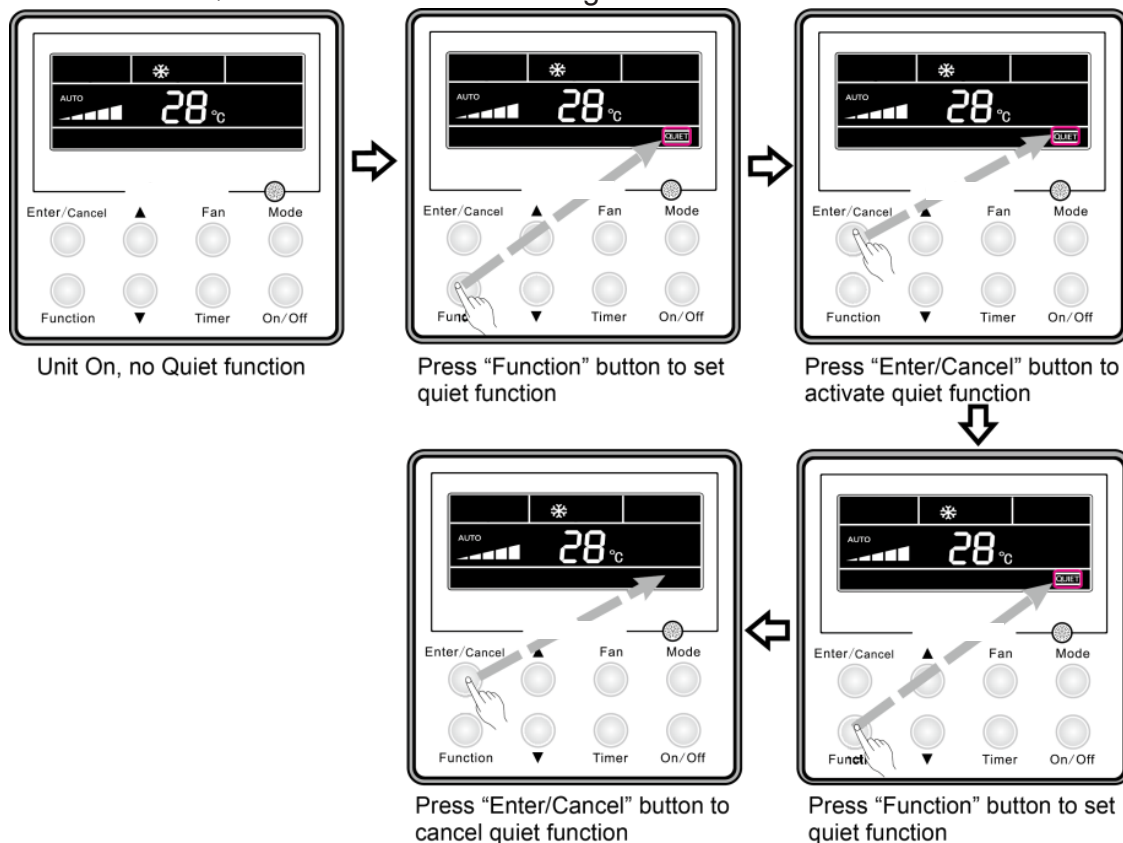

Fig.25 Quiet function setting

Notes:

- ①. "QUIET" function is unavailable in Fan or Dry mode. Owing to power failure, the "Quiet" function is defaulted to be deactivated.
- ②. If quite function is set, turbo function will be canceled.

3.19 Ultra-Dry Setting

Under Dry mode, when the setting temperature is 16°C, press “▼” button twice and the setting temperature will be changed to 12°C, at this time, the unit enters the Ultra-Dry function.

When the Ultra-Dry function is activated, it can be cancelled by pressing “▲” button or pressing “Mode” button to switch mode.

3.20 Other Functions

3.20.1 Lock Function

Under the ON state of the unit without any malfunction or under the OFF state of the unit, press ▲ and ▼ buttons at the same time for 5s till the wired controller enters the lock state. In this case, LCD displays . After that, repress these two buttons at the same time for 5s to quit the lock state.

Under the lock state, no response will be given to the other button operation.

3.20.2 Memory Function

Memory switchover: Under the OFF state of the unit, press the Mode and ▲ buttons at the same time for 5s to switch memory modes. When setting the memory mode, “MEMORY” will be displayed. If this function is deactivated, the unit will go to the OFF state after power recovery.

Memory recovery: If the memory function is On, the wired controller after power failure will resume its original running state upon power recovery.

Note:

It will take about 5 seconds to save data. Therefore, please do not cut down the power at this time, or data will fail to be saved.

3.20.3 Selection of Centigrade and Fahrenheit

Under the OFF state of the unit, press the Mode and ▼ buttons at the same time for 5s, Centigrade and Fahrenheit scales will be switched alternately.

3.20.4 Ambient Temperature Enquiry

Under On/Off status, press “Confirm” button for 5s, it will enter Enquiry interface. At this time, what shows on the timer area is the ambient temperature type: 01 or 02 and the temperature will be shown. “01” means the outdoor ambient temperature and “02” represents the indoor ambient temperature. Press “Mode” button to switch between those two types. Press any other button except Mode button or receive the signal from

the remote controller will quit from the Enquiry function. If there is no operation in 20s, the unit will quit from this function automatically.

Notes:

- ①. If the unit is not connected with the ambient temperature sensor, after 12h electrification, the display of the ambient temperature sensor will be shielded.
- ②. If the outdoor temperature sensor has error, after 12h electrification, the display of the ambient temperature sensor will be shielded.

3.20.5 Indoor fan shutdown mode setting

Under unit OFF status, simultaneously press “Function” and “Timer” button for 5s, the wired controller will enter parameter setting interface. Press “Mode” button to set till “05” is shown on the temperature displayed area. Then the unit will enter the indoor fan shutdown mode.

Two options are available for the indoor fan shutdown mode:

Mode 1: When the temperature reaches certain value, the indoor fan will not be shut down at any mode except heating mode. After the unit is shut down, for the duct type unit and the floor ceiling type unit, the indoor fan will blow the extra heat for 60s and then stop running. For the cassette type unit, its indoor fan will operate at low fan speed and blow the extra heat for 60s only when error happens to it.

Mode 2: No matter the unit is under which mode, the indoor fan will keep running for 10s after the temperature reaches certain value, then it will stop.

Press “▲” or “▼” button to adjust the mode. Under Mode 1/2, “00”/ “01” will show up in the timer area. Then press “Enter/Cancel” button to save the settings. The setting procedures are shown as Fig.26:

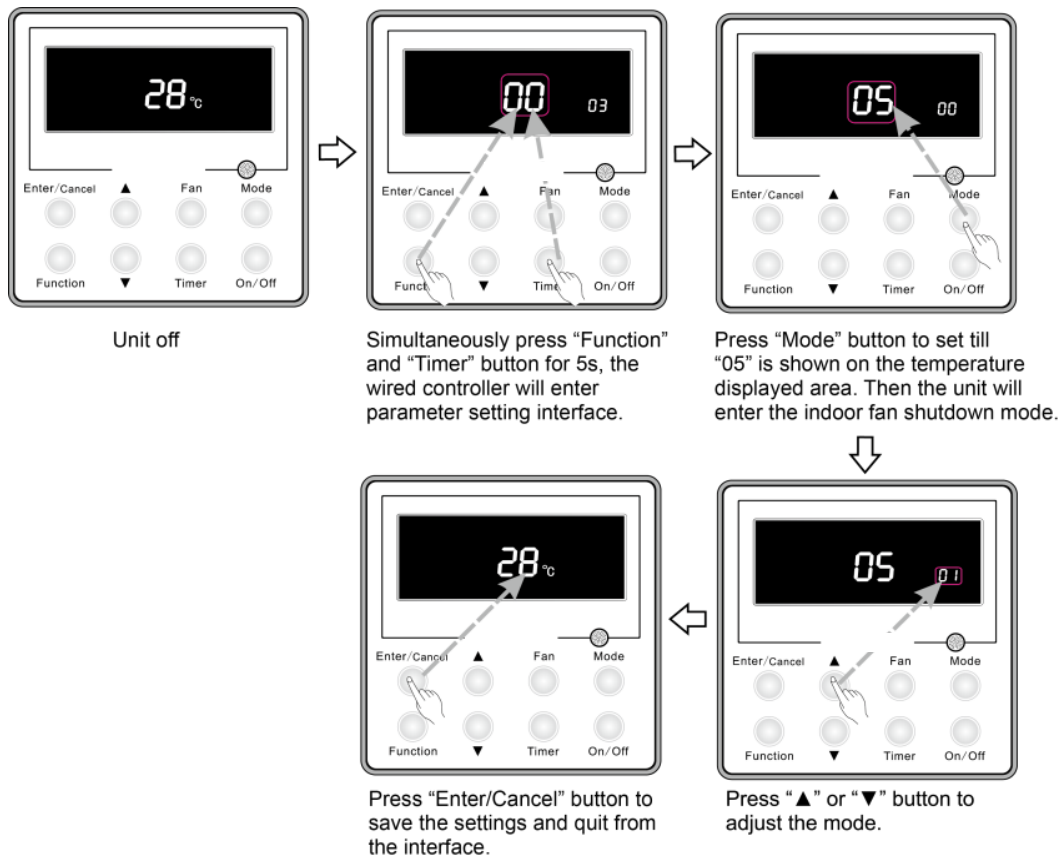

Fig.26 Indoor fan shutdown mode setting

Note:

In the parameter setting interface, only when "05" shown on it, the indoor fan shutdown mode can be set. Other parameters are not allowed to be modified and our company is not responsible for the unit damage or property loss due to parameter changed by customers.

4 Installation of the Wired Controller

4.1 Standard Parts

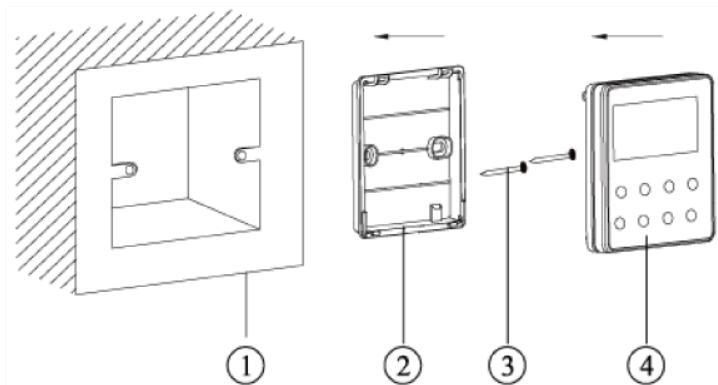

Table 4 Standard Parts

No.	Description	Quantity
1	Base Box	1
2	Soleplate	1
3	Screw M4×25	2
4	Front Panel	1

Fig.27 Standard Parts of the Wired Controller

4.2 Installation Location and Installation Requirements

- (1). Do not install the wired controller in the damp place or under direct sunlight.
- (2). Do not install the wired controller close to the hi-temperature object or place where the wired controller is likely to suffer water spray.
- (3). Do not install the wired controller directly opposite to the window so as to avoid improper operation caused by the interference of the neighbor's same model wired controller.
- (4). Please cut off the power supply of wires embedded in the wall. No operation is allowed with electricity.
- (5). To avoid abnormal operation caused by electromagnetic interference or other causes, please take notice of the following statements during wiring.
 - ①. Be sure the communication line is wired into the correct port, otherwise it would result in communication fault.
 - ②. The communication line (wired controller) and power line must be separated with the minimal distance of 20cm, otherwise it would result in communication fault.
 - ③. Suppose that the air conditioner is installed where likely to suffer electromagnetic interference, the communication line of the wired controller must be shielded twisted pair.

4.3 How to Install the Wired Controller

First of all, the selection and connecting method of the communication line is shown as follows:

Select appropriate communication line of the wired controller: 2-core signal line (wire size $\geq 0.75\text{mm}^2$, length $< 30\text{m}$, recommended length: 8m).

After the indoor unit is de-energized, fix the communication line on the indoor terminal board by screws.

Then, the specific installation steps is shown in the Fig.28:

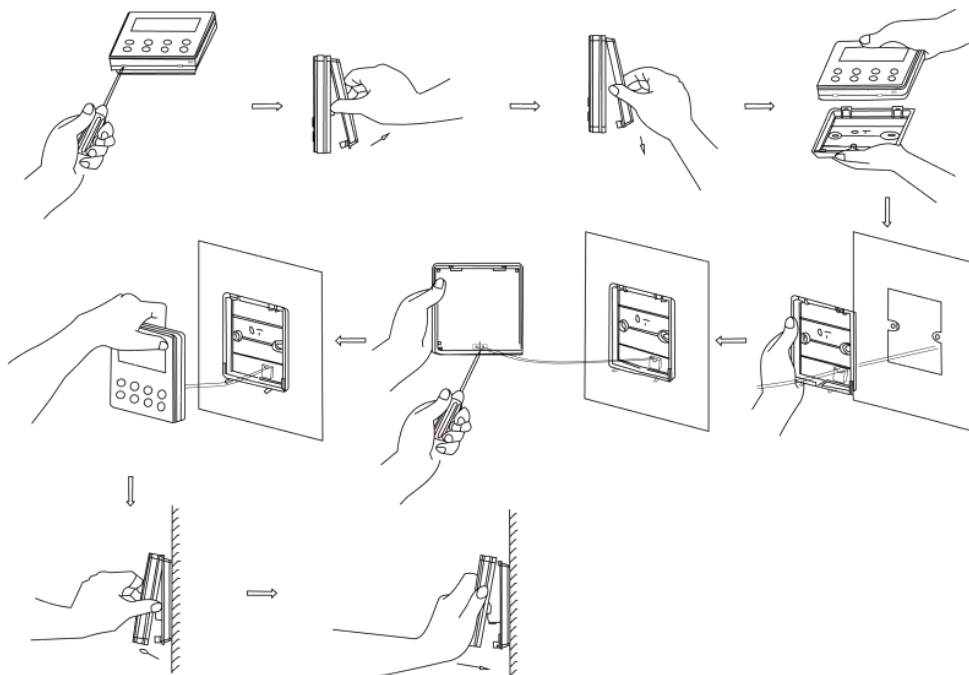

Fig.28 Installation of the Wired Controller

Brief instructions:

- ①. Pull out the 2-core signal line from the mounting hole and pass this line through the round hole located at the bottom of the wired controller.
- ②. Use M4×25 screws to fix the soleplate of the wired controller on the wall.
- ③. Fix the signal line on the copper tabs X1 and X2. Make sure the line is tightly fixed and with no short-circuit potential.
- ④. Set the panel and the bottom together by clasps.

4.4 How to Remove the Wired Controller

The wired controller can be easily removed as shown in Fig.29

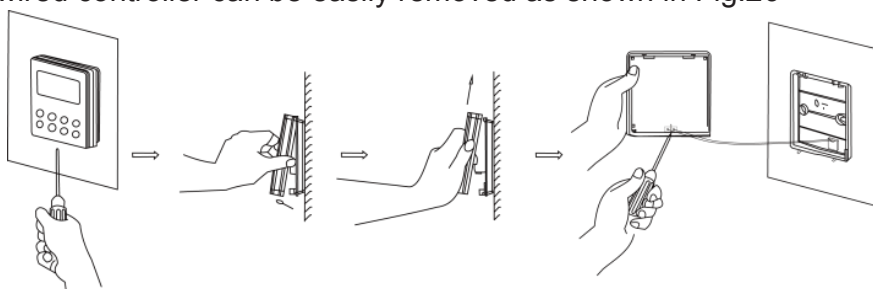

Fig.29 Removal of the Wired Controller

5 Error Display

When error happens to the unit, the error code will be shown on the wired controller. When multiple errors simultaneously happen, the error codes will circularly show up.

When error occurs, please immediately shut down the unit and contact professional personnel.

As shown in the Fig.30 means the high pressure protection.

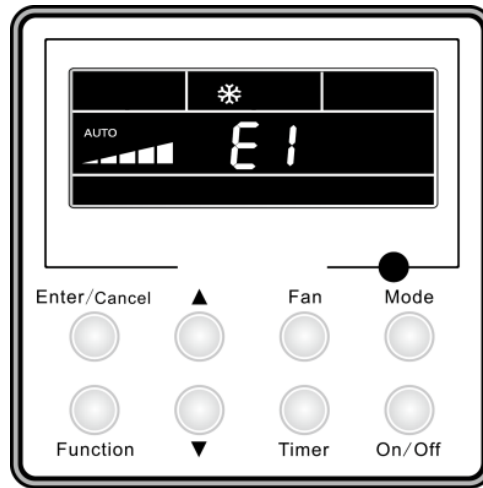

Fig.30

Error codes and their meanings:

Table 5

Number	Error code	Error
1	E1	Compressor high pressure protection
2	E2	Indoor anti-freeze protection
3	E3	Compressor low pressure protection, refrigerant lack protection and refrigerant collecting mode
4	E4	Compressor high discharge temperature protection
5	E6	Communication error
6	E8	Indoor fan motor error
7	E9	Full water protection
8	F0	Indoor ambient temperature sensor error
9	F1	Evaporator temperature sensor error
10	F2	Condenser temperature sensor error
11	F3	Outdoor ambient temperature sensor error
12	F4	Discharge temperature sensor error
13	F5	Temperature sensor error of wired controller
14	C4	Outdoor jumper error
15	C5	Indoor jumper error

16	EE	Outdoor memory chip error
17	PF	Electric box sensor error
18	H3	Compressor overload protection
19	H4	Overloading
20	H5	IPM protection
21	H6	DC fan motor error
22	H7	Drive desynchronizing protection
23	HC	Pfc protection
24	L1	Humidity sensor error
25	Lc	Activation failure
26	Ld	Compressor phase sequence protection
27	LF	Power protection
28	Lp	Indoor and outdoor mismatch
29	dJ	Phase loss or reverse protection
30	U7	4-way valve direction changing protection
31	P0	Drive reset protection
32	P5	Over-current protection
33	P6	Communication error between main control and drive
34	P7	Drive module sensor error
35	P8	Drive module over temperature protection
36	P9	Zero passage protection
37	PA	AC current protection
38	Pc	Drive current error
39	Pd	Sensor connecting protection
40	PE	Temperature drift protection
41	PL	Bus low voltage protection
42	PH	Bus high voltage protection
43	PU	Charge loop error
44	PP	Input voltage abnormality
45	ee	Drive memory chip error
46	oE	malfunctions of outdoor unit, please refer to status of error indicator in outdoor unit



KAISAI

kaisai.com

